

## Planning for an IQ Microinverter System

The Enphase IQ Microinverter system is inexpensive to install and provides a wide range of new installation options to solar professionals. The IQ Microinverter system is the ideal product for single-phase applications. New components available as part of this system provide additional options for reducing Balance of System (BOS) costs and installation complexity. This planning guide introduces solar installation professionals to the new components, provides guidance on component selection, and gives tips for various system design and installation scenarios.

The Enphase IQ Microinverter system includes the following:

- Enphase IQ 6 and IQ 6+ Micros and accessories
- Enphase IQ Envoy or IQ Combiner
- Enphase Q Cable and accessories
- Enphase Enlighten and apps

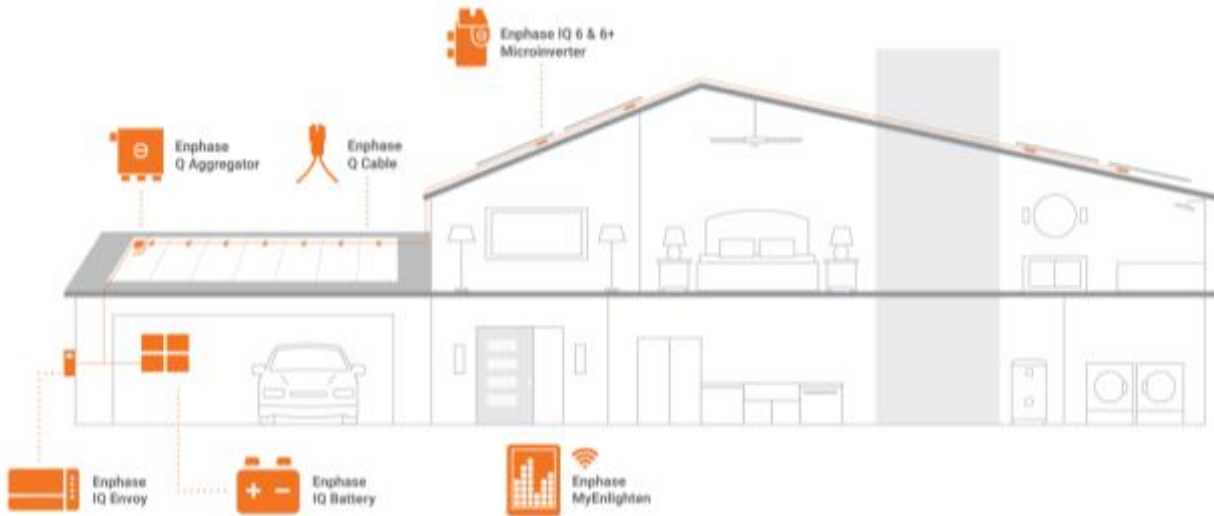
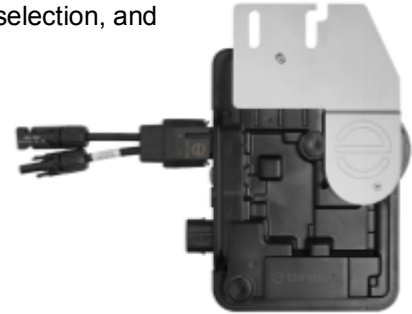

### IQ 6 and IQ 6+ Micros

The IQ 6 and IQ 6+ Micros have a 97% CEC efficiency for split phase applications and are available at peak output power ratings of 240 watts and 290 watts respectively. For a single-phase, 240V application, you can install a maximum of 16 IQ 6 Micros or 13 IQ 6+ Micros on a 20A branch circuit. See the IQ product data sheets for complete product specifications at [Enphase.com](http://Enphase.com).

Maximum IQ Micros per AC branch circuit	IQ 6 Micros (single-phase 240 VAC)	IQ 6+ Micros (single-phase 240 VAC)
	<b>16</b>	<b>13</b>
	IQ 6 Micros (single-phase 208 VAC)	IQ 6+ Micros (single-phase 208 VAC)
	<b>14</b>	<b>11</b>

**IMPORTANT:** Enphase IQ Envoy and IQ 6 and IQ 6+ Micros do not communicate with, and should not be used with, previous generation Enphase Microinverters, AC Batteries, and Envoys. The Q Aggregator and other Q accessories work only with Enphase IQ 6 and/or IQ 6+ Microinverters.

## Q Cable and IQ Micro Accessories





The IQ Microinverter system uses the new Q Cable with only two conductors, resulting in a more lightweight and flexible product. This UL3003 listed DG (Distributed Generation) cabling system is purpose designed for the application, and uses the following new accessories, which are not compatible with earlier Enphase cabling systems.

### Q CABLE TYPES / ORDERING OPTIONS

Model Number	Description	Connector Spacing	PV Module Orientation	Connector Count per Box
Q-12-10-240	Q Cable for 60/72 cell 1.0m portrait module pitch	1.3 m (4.2 ft)	Portrait	240
Q-12-17-240	Q Cable for 60 cell 1.7m landscape module pitch	2.0 m (6.5 ft)	Landscape (60-cell)	240
Q-12-20-200	Q Cable for 72 cell 2.0m landscape module pitch	2.3 m (7.5 ft)	Landscape (72-cell)	200
Q-12-RAW-300	Q Cable, 12 AWG, no connectors, 300m length		Not applicable	

### ENPHASE Q CABLE ACCESSORIES

Name	Model Number	Description
Q Aggregator	Q-BA-3-1P-60	Combines up to three microinverter AC branch circuits into one home run
Field Wireable Q Connector (male)	Q-CONN-10M	Make Q Cable connections to any Q Aggregator open connector or female Field Wireable Q Connector
Field Wireable Q Connector (female)	Q-CONN-10F	Make Q Cable connections to any Q Cable open connector or male Field Wireable Q Connector
Q Clip	Q-CLIP-100	Used to fasten cabling to the racking or to secure looped cabling
Q Cable Disconnect Tool	Q-DISC-10	Disconnect tool for Q Cable connectors, DC connectors, and AC module mount
Q Aggregator Sealing Caps (male)	Q-BA-CAP-10	Male sealing cap for unused Q Aggregator connectors
Q Sealing Caps (female)	Q-SEAL-10	Female sealing cap for unused Q Cable connectors
Q Cable Terminator	Q-TERM-10	Terminator cap for unused Q Cable ends
IQ Replacement DC Adaptor (MC4)	Q-DCC-2	IQ Micro replacement adaptor for MC4 DC connector
IQ Replacement DC Adaptor (UTX)	Q-DCC-5	IQ Micro replacement adaptor for UTX DC connector

	<p><b>Q CABLE TERMINATOR</b> Terminator cap for unused cable ends, sold in packs of ten (Q-TERM-10)</p>		<p><b>Q SEALING CAPS</b> Sealing caps for unused aggregator and cable connections (Q-BA-CAP-10 and Q-SEAL-10)</p>
	<p><b>Q CABLE DISCONNECT TOOL</b> Plan to use at least one per installation, sold in packs of ten (Q-DISC-10)</p>		<p><b>Q CLIP</b> Used to fasten cabling to the racking or to secure looped cabling, sold in packs of ten (Q-CLIP-100)</p>

## Specifying Cabling and Accessories at the Array

The Enphase IQ Microinverter system uses a new and improved cabling system. The Q Cable is DG type and contains only two #12 AWG line conductors. The Q Cable male connectors plug directly into the IQ Micros, whose double insulation rating requires no neutral or ground conductors. This lightweight cable drives down system costs while simplifying installation.



## Designing with Q Cable

### Q CABLE SPECIFICATIONS

Voltage rating	600V (connector rating 250 V)
Cable temperature rating	90° C (194° F)
Certification	UL3003, DG cable
Flame test rating	FT4
Compliance	RoHS, OIL RES I, CE, UV resistant, combined UL for Canada and United States
Cable insulator rating	THHN/THWN-2 dry/wet

IQ Micro part numbers offered with either MC4 or Amphenol UTX DC Adaptors

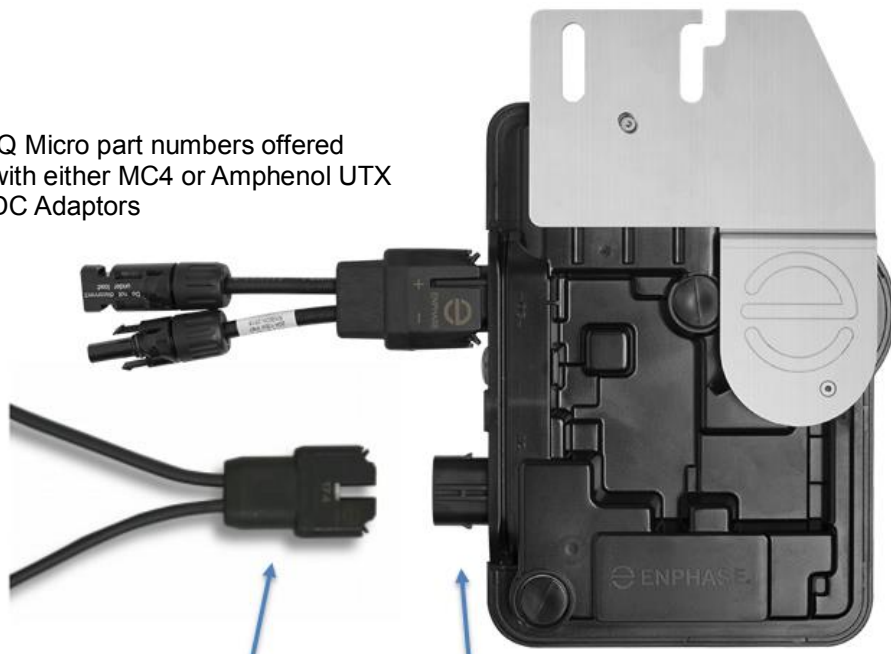

Male connector on Q Cable

Female connector on IQ Micro

Q Cable is a single-phase, two-line conductor cable with integrated AC connectors available in three connector-spacing configurations for different PV module sizes and layouts. Three-phase system configurations will be introduced in Fall 2017. We also offer a raw Q Cable without integrated AC connectors for runs between separated arrays or to a junction box located some distance away from an array.

You must install supports (clips, etc.) for the Q Cable and raw Q Cable at six-foot intervals or less. Installation requirements for wet-rated cable allow Q Cable and raw Q Cable to be installed in conduits, cable trays, and other raceways.

The DG cable standard UL3003 is based upon the construction specifications (wet rated) of TC-ER cable, which may be installed in raceway as per NEC 336.10(3). The Q Cable and raw Q Cable are manufactured with DG cable to the following specifications and listed under the UL 3003 standard:

- E481333 (UL) DG 600V THHN/THWN-2 90°C DRY/WET 2/C 12AWG -40C OIL RES I FT4 CABLEPLUS
- 19 strand conductors

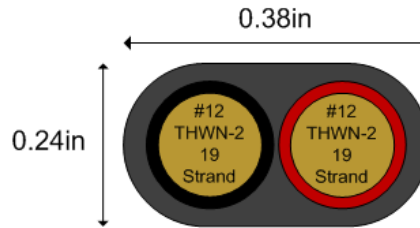

Refer to the UL guide card for DG cable: [http://database.ul.com/cgi-bin/XYV/template/LISEXT/1FRAME/showpage.html?name=QHZR.GuideInfo&ccnshorttitle=Distributed+Generation+Cable&objid=1085285873&cfgid=1073741824&version=versionless&parent\\_id=1085285872&sequence=1](http://database.ul.com/cgi-bin/XYV/template/LISEXT/1FRAME/showpage.html?name=QHZR.GuideInfo&ccnshorttitle=Distributed+Generation+Cable&objid=1085285873&cfgid=1073741824&version=versionless&parent_id=1085285872&sequence=1)

**Terminations at the Q Aggregator**

The Q Aggregator accommodates up to three microinverter AC branch circuits. Connect any open male Q Cable connector to the female connector on the Q Aggregator. The Q Aggregator provides built-in 20 A over-current protection for each microinverter AC branch circuit and the ability to run one combined set of output conductors off the roof, further reducing BOS costs and making wire pulls easier. Optionally, you can attach a male Field Wireable Q Connector to the end of a Q Cable or a raw Q Cable and plug it into the Q Aggregator.

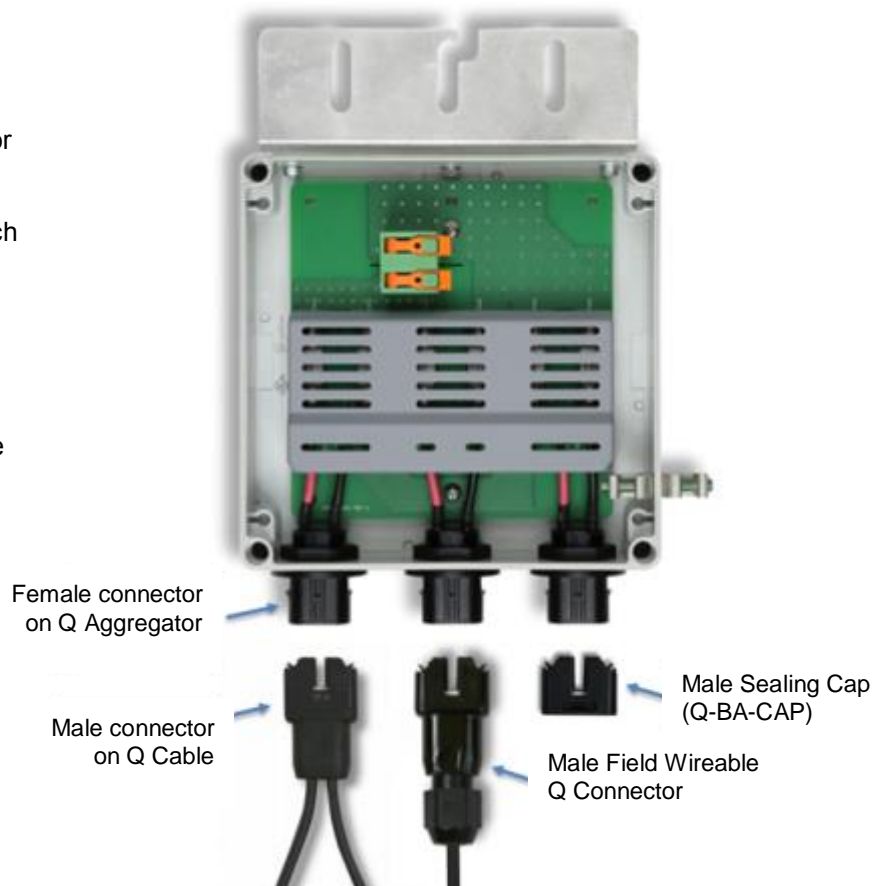

**Field Wireable Q Connectors**

You can use the male or female Field Wireable Q Connectors to extend the Q Cable (with connectors) or the raw Q Cable (without connectors). Installers assemble the Field Wireable Q Connectors using a crimp tool and the provided terminals.

Enphase recommends the Multi-Contact PV-CZM-18100, -19100, or -22100 crimp tools.

Each male or female Field Wireable Q Connector includes the corresponding male or female terminals, so be sure to keep the terminals separate, as they are not interchangeable.

**Note:**

- Use only the provided terminals, and do NOT use the Field Wireable Q Connectors with other types of terminals.
- Use the Field Wireable Q Connectors only with Enphase Q Cable, and do NOT use other types of cables or conductors.

**FEMALE CONNECTOR PARTS**

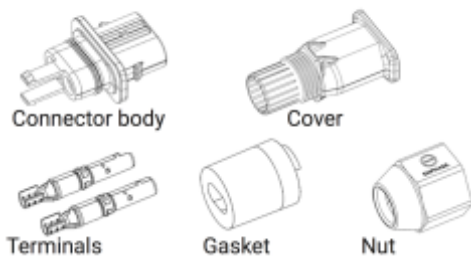

**MALE CONNECTOR PARTS**

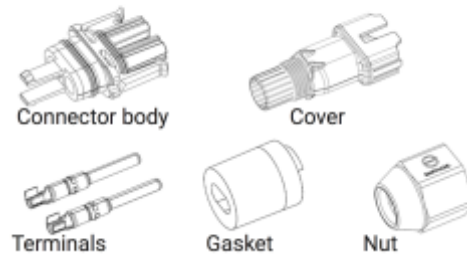

Connector Type	Will connect to
Field Wireable Q Connectors (Male)	Q Aggregator, IQ Microinverter, or a female Field Wireable Q Connector
Field Wireable Q Connectors (Female)	Q Cable connector or a male Field Wireable Q Connector

When the microinverters are located some distance from the roof top junction box or Q Aggregator, it may be most economical to use raw Q Cable (without connectors) to run across an array or to run through raceway, conduit or a chase to another array.

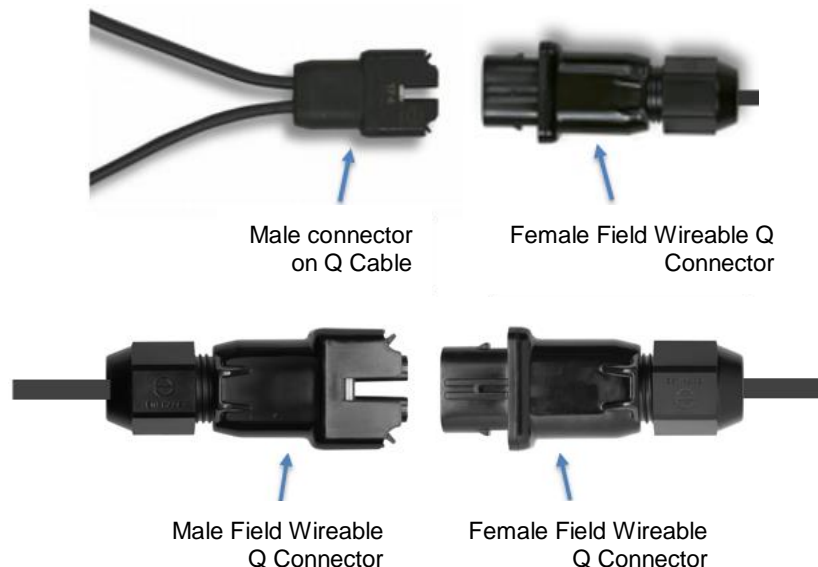

### Sealing Caps

You must seal each unused Q Cable connector with a watertight sealing cap (Q-SEAL).

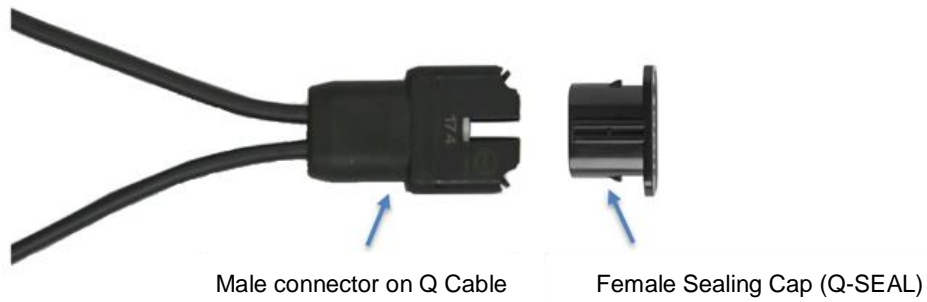

Seal each unused connector on the Q Aggregator with a male sealing cap. Also, during construction, you must use male sealing caps to temporarily seal any exposed IQ Micro connectors, that are not connected to the Q Cable, to protect against moisture or water damage at the exposed connector.

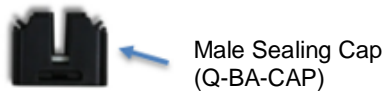

### Q Terminator

Install a terminator cap on any cut end of Q Cable that is not terminated with a Field Wireable Q Connector.



## IQ System Design using the IQ Combiner

Enphase has developed a UL listed IQ Combiner with integrated IQ Envoy for use with the IQ System. Using an IQ Combiner makes the customer “storage ready,” as it also allows connection of Enphase IQ Battery circuits. The IQ Combiner installation and design is like the previous Enphase AC Combiner Box. The primary difference is that it includes a pre-installed IQ Envoy. The IQ Combiner allows for any combination of up to three branch circuits of IQ Micros or IQ Batteries to be terminated within the enclosure. It’s important that only Line 1 of each solar microinverter AC branch circuit passes through the Production CT, as the IQ Battery circuits should not be measured by the Production CT for proper storage system function. You may run multiple Line 1 conductors for each solar microinverter AC branch circuit through the production CT. The IQ Combiner includes three 20 A overcurrent protection circuit breakers for the individual microinverter AC branch circuits, and a 5 A circuit breaker for protecting and switching the IQ Envoy. The outdoor-rated enclosure of the IQ Combiner offers protection for the IQ Envoy, Mobile Connect cellular (optional), and revenue-grade production metering.



When using the Q Aggregator for combining multiple branch circuits on the roof, the combined production circuit cannot be terminated on any of the 20 A circuit breakers within the IQ Combiner. It is still possible to use an IQ Combiner in a system that uses a Q Aggregator for purpose of housing the IQ Envoy, but in this scenario, the Q Aggregator combined output circuits must land at a separate breaker rated for the combined inverter output current in a separate subpanel. Keep in mind that Line 1 of the combined output circuit coming from the Q Aggregator must still pass through the production CT within the IQ Combiner, if the system will be equipped with such.

**Conceptual Schematic of IQ Combiner Installation**

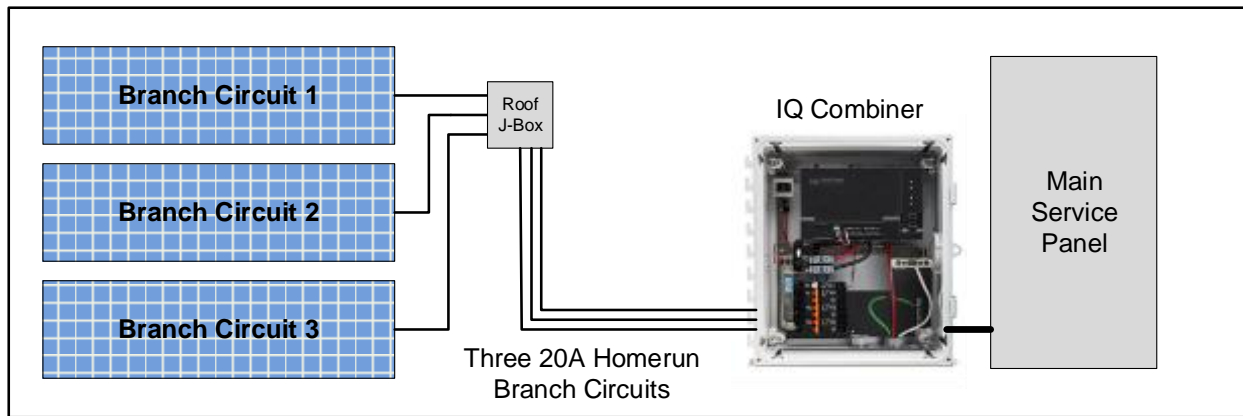

**IQ System Design with Q Aggregator**

The IQ Microinverter system introduces a new rooftop mounted, single-phase Q Aggregator (Q-BA-3-1P-60), which enables plug and play termination and combining up to three microinverter AC branch circuits at a single location. The Q Aggregator offers additional design options and can help to lower balance of system installation costs for many projects.

Q AGGREGATOR SPECIFICATIONS	
Model number	Q-BA-3-1P-60
Dimensions	190 mm (W) x 227 mm (D) x 80 mm (H) [7.5 in (W) x 9 in (D) x 3.2 in (H)]
Enclosure rating	NEMA3 (up to 45° from horizontal)
Temperature range	-40° C to +55° C (-40° F to +122° F)
Compliance	UL1703, EN62109, UL6703A



## Design Considerations for the Q Aggregator

The Q Aggregator:

- Is a roof mounted combiner box, which supports up to three circuits.
- Requires protection at the feeder panel by an over current protective device (OCPD) rated at an ampacity not to exceed 60A. Make sure the conductor size selected for field wire from Q Aggregator to the service connection is adequate for the OCPD chosen.
- Allows for a single homerun back to the service of #12 to #4. The homerun must consist of two ungrounded conductors (hots) and one ground conductor to provide equipment grounding for the racking and modules as required.
- Does not need neutral. A neutral is not needed for the IQ system on the roof and need not be provided at the Q Aggregator.
- Includes 20A fuses permanently installed on the fuse board contained within the Q Aggregator for providing individual over current protection for each of three branch circuits. The fuses are not consumer serviceable and are labeled as such on the lid of the Q Aggregator.
- Must be installed underneath a solar module on the roof and out of the direct sunlight. You may install the Q Aggregator beneath a solar module, as per NEC 690.34 Access to Boxes.
- Ships with a mounting bracket for rail-based mounting where the mounting flange is flush with the lid of the enclosure. Installers can rotate the mounting bracket so it is flush with the bottom of the enclosure for mounting on an L-foot (e.g., for rail-less racking systems that do not have a rail to which to mount the Q Aggregator).
- Requires sealing caps (Q-BA-CAP) to seal unused connectors on Q Aggregator. (These are the male connectors/caps.) Each Q Aggregator ships with one spare Q-BA-CAP. If all three circuits are used, we recommend that you keep the unused cap for a future installation.
- Greatly facilitates *center-feeding*. *Center-feeding* is the process of dividing a branch circuit into two or more sub-branch circuits. When using Q Cable and the Q Aggregator, a center-fed branch circuit is a single cable that can be fed from the Q Aggregator at any position along the circuit where an open connector is available. **Never loop back a circuit to more than one connection on the Q Aggregator.**



## IQ Envoy Installation Options

When installing the Q Aggregator, you must consider the location of the IQ Envoy. The IQ Envoy is installed in an enclosure. Some options are detailed below.

### ***IQ Combiner with Factory-Installed IQ Envoy***

The IQ Envoy can be factory-installed as part of the Enphase IQ Combiner, but in that case the Q Aggregator circuit cannot terminate in the IQ Combiner if the total of the Q Aggregator's microinverter output circuits exceed 16A. The IQ Combiner with IQ Envoy contains three 20A branch circuit breakers and cannot support larger breakers at this time.



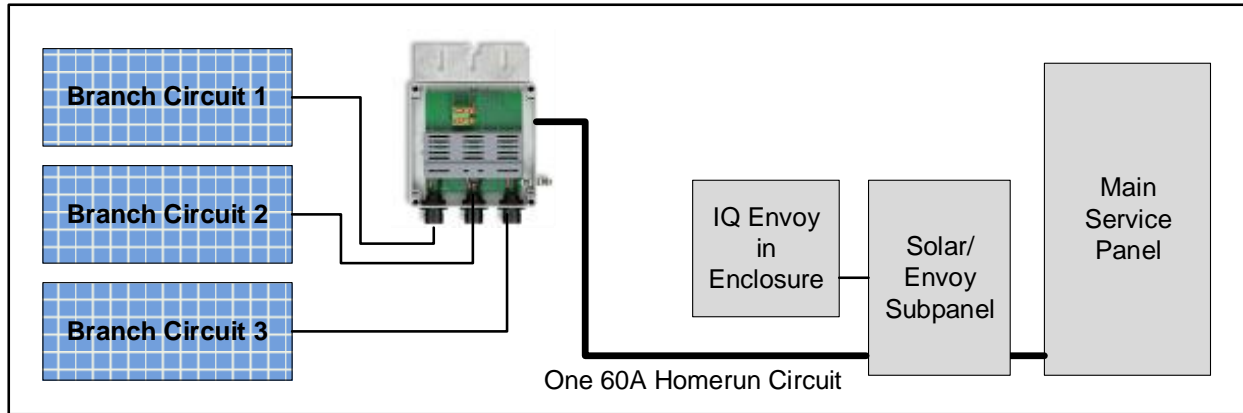

### *Installing IQ Envoy in an Outdoor Enclosure*

The IQ Envoy must be installed inside of an electrical enclosure, keeping the operating temperature of the Envoy in mind. This enclosure must be large enough to house the IQ Envoy and a dedicated receptacle to power the IQ Envoy. The enclosure can be metal or non-metallic, but should be non-metallic if Wi-Fi or cellular networks will be used for the IQ Envoy Internet connection. The enclosure must meet the following requirements:

- Use a NEMA type 3R, 4, or better rated outdoor enclosure with hinged cover or screw cover of suitable dimensions. Typical enclosure dimensions are in the range of 10" x 10" x 4" to 12" x 12" x 6".
- The IQ Envoy does not ship with a plug-in style power cord, and must be connected to two lines and a neutral for power and for production and consumption monitoring. Therefore, a receptacle is not required in the enclosure for powering the IQ Envoy.
- If an Ethernet over power line communication (PLC) bridge is desired, you can install a receptacle inside the enclosure. The enclosures listed below provide adequate room for a receptacle, if needed.
- The enclosure should be installed in a location that is shaded from extensive periods of direct sunlight. The IQ Envoy is rated for ambient temperatures of -40°F to 115°F when installed in an enclosure.
- If mounted outdoors, **do not** drill holes on the top of the enclosure or anywhere that allows moisture ingress.
- Place in a location that is accessible by service personnel without requiring indoor access.

**Enclosure Options for the IQ Envoy**

**Arlington EB1212-BP Enclosure with back plate**

- Lockable unit dimensions are 12" x 12" x 4"
- Easily accommodates the addition of a field-wired receptacle, if needed
- Outdoor rated with hinged door opening upward, but indoor rated with hinge to side



**Orbit 57905 Timer Cabinet**

- Back plate included, NEMA3R, lockable
- Approximate dimensions are 11"x10"x5"
- Includes a receptacle pre-installed (not wired)
- Mounting plate and IQ Envoy must be removed to install back mounting screws
- Tight wiring space for IQ Envoy with PLC bridge



**Integra H12104H\*\*\* Enclosures**

- Strong metal or poly backplate options, NEMA4, lockable
- Approximate dimensions are 10"x12"x5"
- Easily accommodates addition of a field wired receptacle, if needed
- Manufacturer provides a wide variety of enclosure options, including mounting tabs, and vents



**Attabox AH12106 Enclosure with BP1210A back plate**

- Strong metal or poly backplate options, NEMA4, lockable
- Approximate dimensions are 10"x12"x5"
- Easily accommodates the addition of a field wired receptacle, if needed
- Manufacturer provides a wide variety of enclosure options, including mounting tabs, and vents

**Cantex 5133714 Enclosure with Cover and Gasket**

- NEMA4, PVC electrical enclosure
- Approximate dimensions are 12" x 12" x 6"
- Requires eight screws to install or remove cover and gasket



## Field Wireable Q Connectors and Raw Q Cable

The IQ Microinverter System makes complex installations simple.

Field Wireable Q Connectors (Q-CONN-10F and Q-CONN-10M) and raw Q Cable (Q-12-RAW-300) allow a wide-range of installation options that are not available in DC systems or other microinverter systems. You can run raw Q Cable through conduits, raceways, or chases between sub-arrays to help to minimize the amount of conduit, conduit bending, wire-pulls, and wiring connections that are required on a project.

The raw Q Cable is available in 300m (938ft) cable rolls (Q-12-RAW-300).

You must terminate the raw Q Cable in one of the following manners:

- Into a junction box using a ½” service entrance (SE) strain reliefs or UF cable glands
- With a Field Wireable Q Connector (male or female)

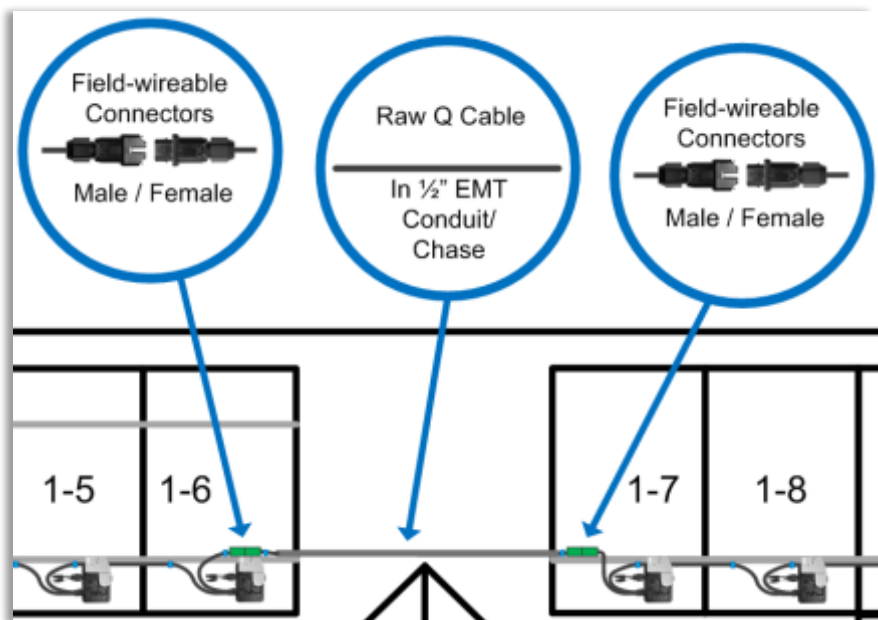
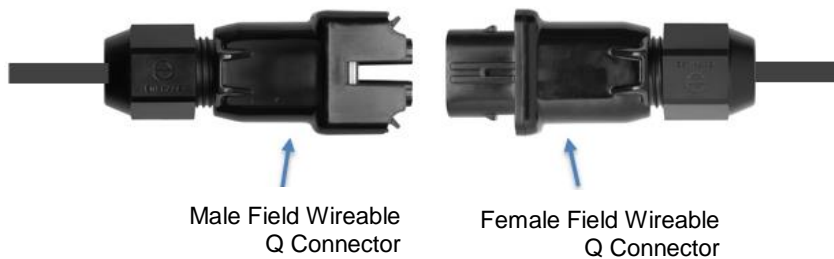

## Splicing Q Cable and Raw Q Cable with Junction Boxes

For complex installations that include multiple arrays, it is possible to use raw Q Cable (Q-12-RAW-300) to service the arrays and branch circuits that do originate directly at the primary roof mounted junction box. In the case that Field Wireable Q Connectors are not readily available, a small junction box may be used to splice two sections of Q Cable together or may be used to splice Q Cable to raw Q Cable.

The raw Q Cable is available in 300m (938ft) cable rolls (Q-12-RAW-300).

You must terminate the raw Q Cable in one of the following manners:

- Into a junction box using a ½" service entrance (SE) strain reliefs or UF cable glands
- With a Field Wireable Q Connector (male or female)

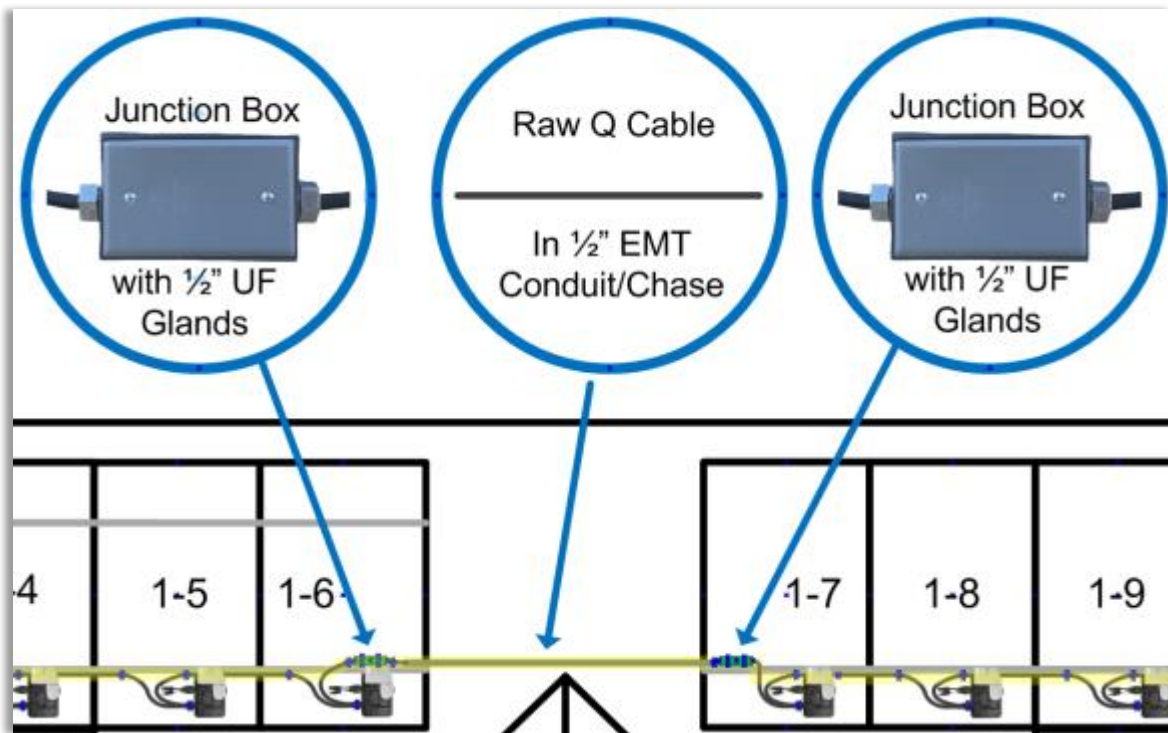

## Example IQ Microinverter System Layouts and Bill of Materials (BOMs)

### Conceptual Image

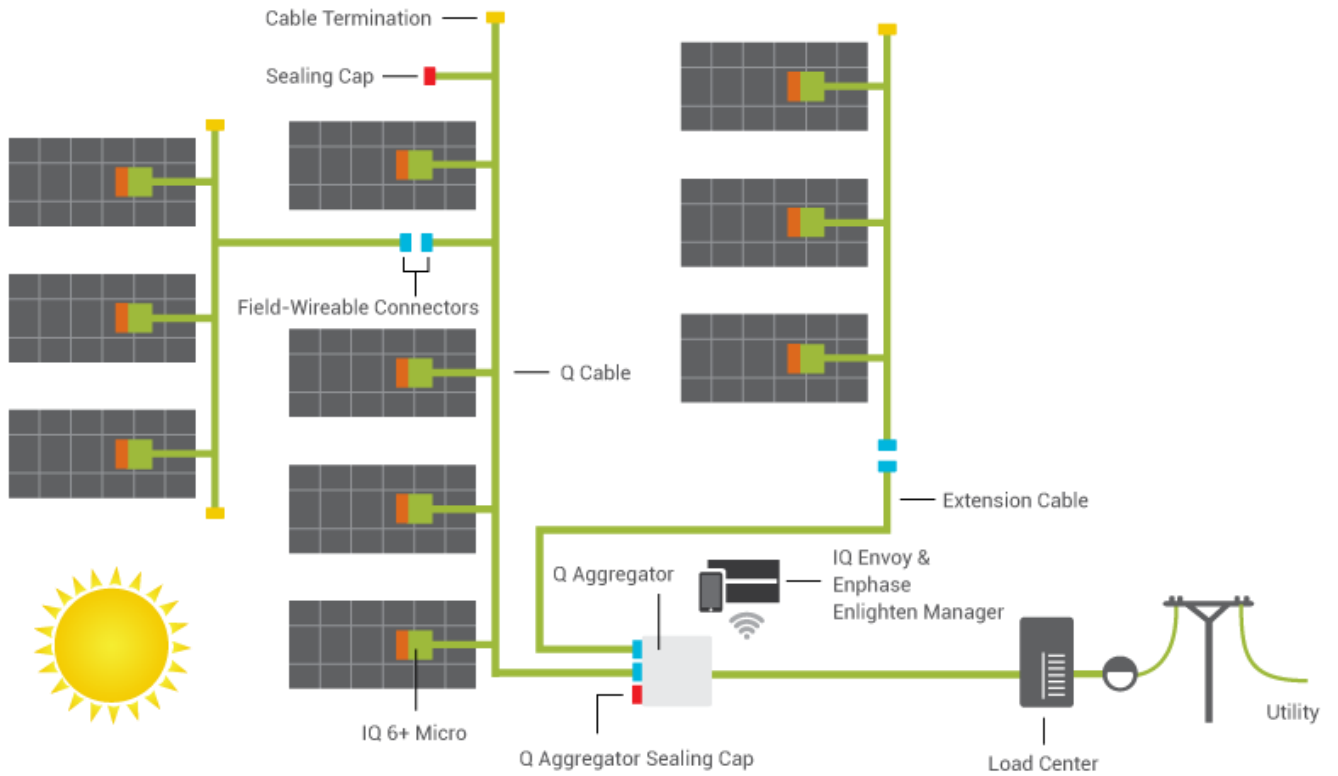

**Scenario 1: Simple 12 Module Scenario**

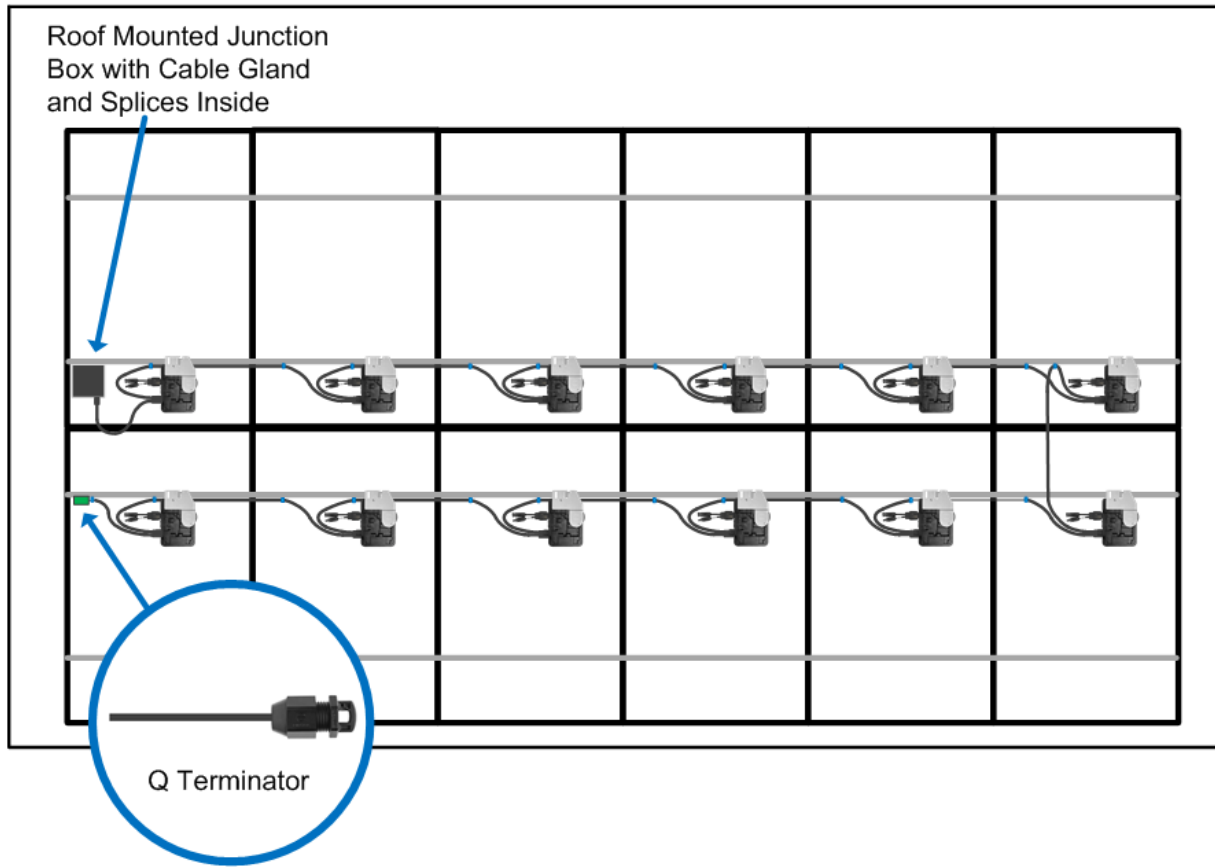

**Bill of Materials for Scenario 1: Simple 12 Module Scenario**

QTY	Part Number	Description
12	IQ6PLUS-72-2-US	Enphase IQ 6+ Microinverter, compatible with 60- and 72-cell PV modules, 290VA peak power, MC4 DC connectors, female AC connector
12 of 240	Q-12-10-240	Q Cable for 60/72 cell 1.0m portrait module pitch. Connector pitch is 1.3m. 240 Male connectors plus two bonus link connectors
0 of 10	Q-SEAL-10	Female sealing cap for unused Q Cable connectors. Pack of 10
1 of 10	Q-TERM-10	Q Terminator for Q Cable ends. Center feed requires two per branch. Pack of 10
21 of 100	Q-CLIP-100	Q Cable rail mount cable management clip. Pack of 100
1 of 10	Q-DISC-10	Disconnect tool for Q Cable connectors, MC and Amphenol DC connectors, and AC module mount. Pack of 10
1	X-IQ-AM1-240-B M	Enphase IQ Combiner with IQ Envoy, 60A, single phase, revenue grade accuracy (ANSI C12.20 +/- 0.5%) with calibrated solid-core CT

**Scenario 2: 24 Module, Two Strings of 12, Terminated at Junction Box**

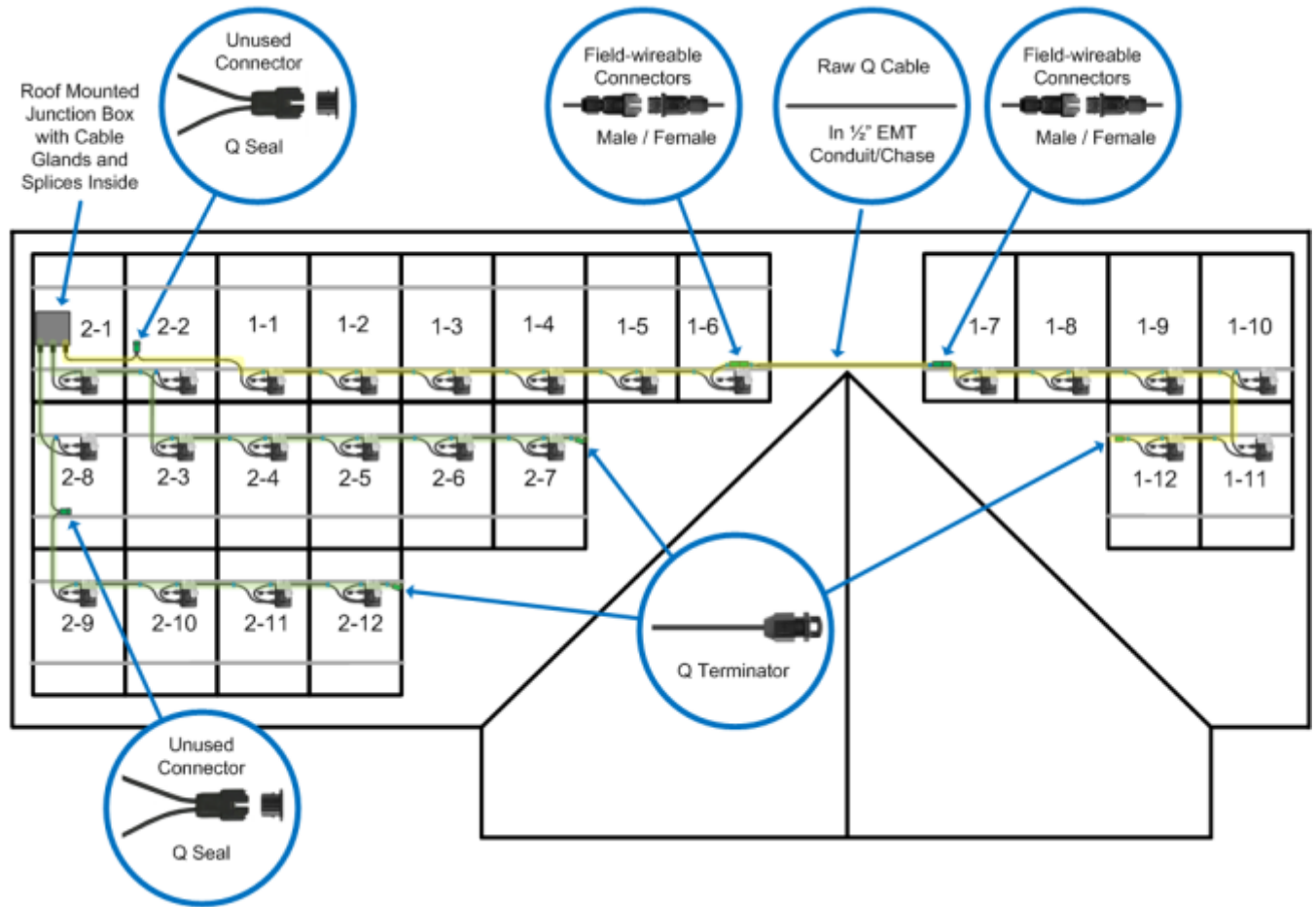

**Bill of Materials for Scenario 2: 24 Modules, Two Strings of 12 Terminated at Junction Box**

QTY	Part Number	Description
24	IQ6PLUS-72-2-US	Enphase IQ 6+ Microinverter, compatible with 60- and 72-cell PV modules, 290VA peak power, MC4 DC connectors, female AC connector
26 of 240	Q-12-10-240	Q Cable for 60/72 cell 1.0m portrait module pitch. Connector pitch is 1.3m. 240 Male connectors plus two bonus link connectors
x ft of 938	Q-12-RAW-300	Q Cable, 12 AWG, no connectors, 300m (984ft) length
2 of 10	Q-SEAL-10	Female sealing cap for unused Q Cable connectors. Pack of 10
3 of 10	Q-TERM-10	Q Terminator for Q Cable ends. Center feed requires two per branch. Pack of 10
2 of 10	Q-CONN-10F	Female Field Wireable Q Connector for Q Cable. Pack of 10 connector bodies with 25 Female MC4 Tool crimpable terminals
2 of 10	Q-CONN-10M	Male Field Wireable Q Connector for Q Cable. Pack of 10 connector bodies with 25 Male MC4 Tool crimpable terminals
47 of 100	Q-CLIP-100	Q Cable rail mount cable management clip. Pack of 100
1 of 10	Q-DISC-10	Disconnect tool for Q Cable connectors, MC and Amphenol DC connectors, and AC module mount. Pack of 10
1	X-IQ-AM1-240-B M	Enphase IQ Combiner with IQ Envoy, 60A, single phase, revenue grade accuracy (ANSI C12.20 +/- 0.5%) with calibrated solid-core CT

**Scenario 3: 24 Module, Two Strings of 12, Terminated at Q Aggregator**

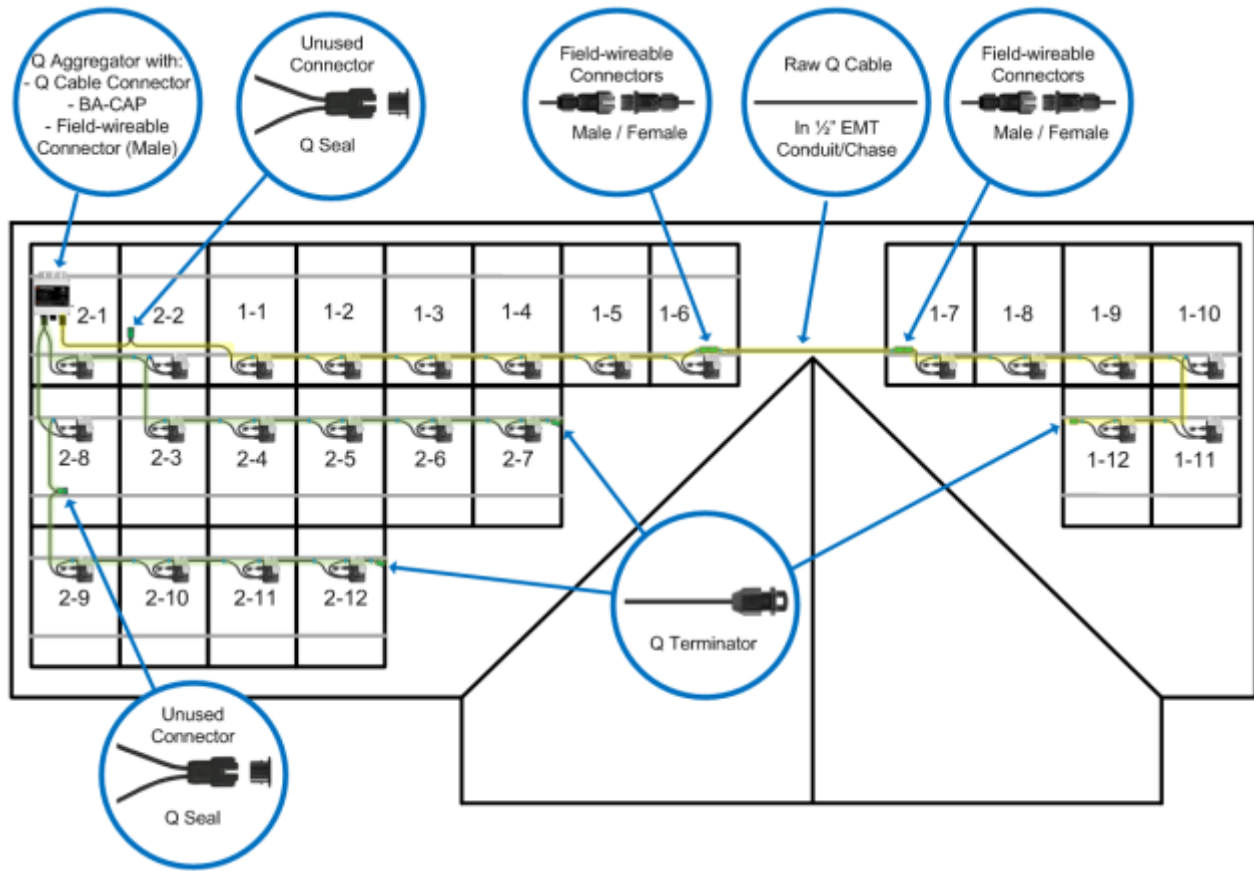

**Bill of Materials for Scenario: 24 Modules, Two Strings of 12 Terminated at Q Aggregator**

QTY	Part Number	Description
24	IQ6PLUS-72-2-US	Enphase IQ 6+ Microinverter, compatible with 60- and 72-cell PV modules, 290VA peak power, MC4 DC connectors, female AC connector
27 of 240	Q-12-10-240	Q Cable for 60/72 cell 1.0m portrait module pitch. Connector pitch is 1.3m. 240 Male connectors plus two bonus link connectors
x ft of 938	Q-12-RAW-300	Q Cable, 12 AWG, no connectors, 300m (984ft) length
2 of 10	Q-SEAL-10	Female sealing cap for unused Q Cable connectors. Pack of 10
3 of 10	Q-TERM-10	Q Terminator for Q Cable ends. Center feed requires two per branch. Pack of 10
2 of 10	Q-CONN-10F	Female Field Wireable Q Connector for Q Cable. Pack of 10 connector bodies with 25 Female MC4 tool crimpable terminals
2 of 10	Q-CONN-10M	Male Field Wireable Q Connector for Q Cable. Pack of 10 connector bodies with 25 Male MC4 tool crimpable terminals
47 of 100	Q-CLIP-100	Q Cable rail mount cable management clip. Pack of 100
1 of 10	Q-DISC-10	Disconnect tool for Q Cable connectors, MC and Amphenol DC connectors, and AC module mount. Pack of 10
1	Q-BA-3-1P-60	Single-phase branch aggregator, One to three female inputs, 60A max 2L+PE output. Includes one Q-BA-CAP
1 of 10	Q-BA-CAP-10	Male sealing cap for Q Aggregator and microinverter AC bulkhead. Pack of 10
1	ENV-IQ-AM1-240 M	Enphase IQ Envoy, single phase, metered. Revenue grade accuracy (ANSI C12.20 +/- 0.5%) with calibrated solid-core CT



## Wire Management of AC and DC Cables Under Array

Since the Q Cable contains only two conductors, it is much smaller and lighter than the previous generation Engage Cable. For this reason, we use cable clips with a reduced wire retention area for the Q Cable. The outer dimensions of the Q Cable allow it to be supported by many of the existing PV cable clips and USE-2 cable clips that are frequently used for supporting the DC module leads today.

Enphase has evaluated and developed wire clips for a wide variety of applications; including rail based applications, rail-less applications, and AC Module applications. These clips are listed later in this section.

### DC Cable Adapters for IQ Microinverters

The IQ 6 and IQ 6+ Micros ship with either MultiContact MC4 DC connectors or Amphenol UTX DC connectors, depending on the part number ordered. You can remove the DC connector assembly on the microinverter and replace it using the Disconnect tool for Q Cable connectors (Q-DISC). You can use this tool to disconnect both the AC and DC connectors on the microinverter and disconnect MC4 and UTX connectors. When the AC Module with Enphase IQ Micro becomes available, the Disconnect tool also provides the means to releases the microinverter install snaps to lower the inverter into shipping orientation if needed.

Replacement adaptors are available for IQ Microinverters:

Q-DCC-2	IQ Microinverter Replacement Adaptor for MultiContact MC4 DC Connector
Q-DCC-5	IQ Microinverter Replacement Adaptor for Amphenol UTX DC Connector

Disconnect Tool



### Wire Management Clips for Attaching Q Cable to Solar Mounting Rails

The Enphase Q Clip (Q-CLIP-100) allows you to manage one or two Q Cables or raw Q Cables to a solar mounting rail. We have evaluated a large selection of racking systems and have found that this clip works with about 90% of the racking systems available. These clips support the cable along the rail and may be adequate for supporting the cabling during row to row transitions (depending on cable length), but additional support may be provided from module frame clips. Use at least one clip or other support for every six feet of cable.



### Wire Management Clips for Attaching Q Cable to Module Frames for Rail-less and AC Module Applications

There are a variety of products available for supporting DC module leads off the roof. Most of the wire clips available for PV cable and for USE-2 cable can also be used to attach Q Cable to module frames. Attaching Q Cable to module frames can be useful for rail-less racking systems since there is no rail to support the

cabling on. Also, for AC Module installations, it is often more convenient to clip the Q Cable to the module frame than to clip the Q Cable to the racking system (if available).

You must support the Q Cable and raw Q Cable at intervals not to exceed 6 feet and make sure that the cable does not touch the roof surface.

Manufacturer	Model	Image
Nine Fasteners	DCS-1307 PV cable clip DCS-1306 USE-2 cable clip	
Burndy / Wiley Electronics	ACME ACC-PV PV cable clip	
Heyco Products	SunRunner PV cable clip	

### Supporting the DC Module Leads

Prepare the modules using clips on the DC module leads to prevent the leads from resting on the roof. It is best to prepare the modules on the ground, before installation. Install the wire clips and DC module leads to allow for easy connection to the microinverter while also supporting the conductors off the roof.



Once the modules are prepared, install them on the racking. Secure any loose wires or cables to the module frames with properly sized wire clips. Ensure that all conductors are supported off the roof.

## AC Wire Management at the Junction Box or Q Aggregator

Wire management practices at the junction box are critical to the long-term reliability of any PV system. Installers often install the roof-mounted junction box on the side of a rail. If using the Q Aggregator, it must be installed underneath the modules.

### *For Junction Box Applications*

Follow these recommendations to prevent moisture from accumulating in the junction box. This helps to improve system reliability while ensuring that the wiring connections last for the life of the system.

- Make sure that cables enter the junction box from the side or from the bottom, never from the top where water can enter the enclosure.
- Install cables with a drip loop. Secure the cable so that water drains away from the cable entry.
- Use properly sized strain reliefs and cord grips. Note that the Q Cable is elliptical, so the cable gland securing the Q Cable must contain an inner gland designed for elliptical cable. These cable glands are commonly available from electrical distributors or home improvement stores and are often available under the following names:
  - ½" Service Entrance (SE) Watertight Connectors
  - UF Cable Gland (such as the Arlington UF50 Cable Connector)
- Properly tighten the strain reliefs to prevent cable movement and to prevent water ingress.
- Install the junction box to meet the manufacturer's recommended mounting and orientation requirements. Use NEMA 4 enclosures. (NEMA 3 enclosures have a limited mounting orientation range and may not accommodate typical rooftop installations.)
- Consider drilling a small drain hole in the bottom, lowermost corners of the junction box, so that moisture or condensate can drain out of the junction box.

### *For Q Aggregator Applications*

- Install the Q Aggregator underneath the solar modules.
- Be sure to seal any unused connectors on the Q Aggregator with the male sealing caps (Q-BA-CAP).
- Always install the Q Aggregator with the removable cover facing upward, and at angles below 45° from horizontal, to ensure the NEMA 3 rating. The Q Aggregator ships with drain holes in the bottom, so must be installed with the cover facing up, even on ground mounted installations.
- The mounting bracket is reversible in the event a bottom mounting position is needed.

## Installing IQ Microinverters with Frame Mount Bracket

You can use the Enphase Frame Mount to attach the Enphase Microinverters directly to module frames. This may be the ideal solution for rail-less racking solutions, whether residential or commercial. When using the Enphase Frame Mount product, you can support the Q Cable to keep it off the roof by clipping it to the module frames using the same module edge wire clips that work with PV cable and USE-2 cable.



## Installing the Power Line Filter (Q-LCF-064-1)

The IQ Microinverter system uses a new generation of Power Line Communication (PLC), making device detection and communication between the IQ Micros and IQ Envoy the fastest and most robust yet. For advanced functionality and Home Energy Systems that use the Enphase IQ Battery, the IQ Envoy will not only monitor the generation and storage devices, but also control them. Best practices described in this document around IQ Envoy location and electrical connection within the system provide the best approach for ensuring strong and lasting PLC performance. In the rare instances where local conditions on the electrical system have noise levels that interfere with the PLC, optional single-phase line communication filtering that isolates the Enphase Home Energy System equipment from the noise source and/or rest of the electrical system at the site, is now available.

The single-phase line communication filter (Q-LCF-064-1) provides line-to-line filtering specifically for IQ systems, but is not required for most systems and should not be specified in every design of residential systems. When needed, the line filter provides a reliable means to mitigate issues with site electrical noise should they arise and interfere with communications. To minimize the cost of adding line filtering to a system, it makes sense to design the system so that a filter can be retrofitted into the system later with ease. Simply locate the IQ Envoy and the IQ Microinverter circuits off a common sub panel. The IQ Combiner is perfect for that purpose. If designing a system with a Q Aggregator, we recommend landing the Q Aggregator output circuit in a sub panel alongside the IQ Envoy so it does not have to later be moved to the array side of a line filter, should that be added.

The single-phase line communication filter may also be used to separate communication domains of sites that have multiple Envoy's, or sites where a neighbor's home also has an Enphase Microinverter system. The PLC signals used for communicating between the IQ Envoy and the IQ Microinverters is fundamentally different from the PLC signals used with previous generation Enphase Microinverter systems. The IQ Micros use line-to-line communications, where previous generation Enphase Microinverter systems use line to neutral communications. For this reason, the IQ systems are not compatible with previous generation Enphase Microinverter systems. Enphase will continue to provide microinverter and Envoy products that are compatible with legacy systems, and line filtering may be used to isolate an Enphase IQ Microinverter System from a previous generation Enphase Microinverter systems.

**Specifications of Q-LCF-064 Filter**

- Shall be installed within a suitable enclosure.
- Wire Enphase IQ Envoy/Micros on the load side and utility/site loads on the line side of the filter.
- Wiring terminals accept #4 to #22 conductors
- 250Vac / 64A maximum continuous inverter output current rating
- Protect with maximum 80A overcurrent protection device (OCPD)
- -25°C to 65°C
- Recommended tightening torque of 2 to 2.8 Nm

**Schematic of Q-LCF-064 Filter Installation**

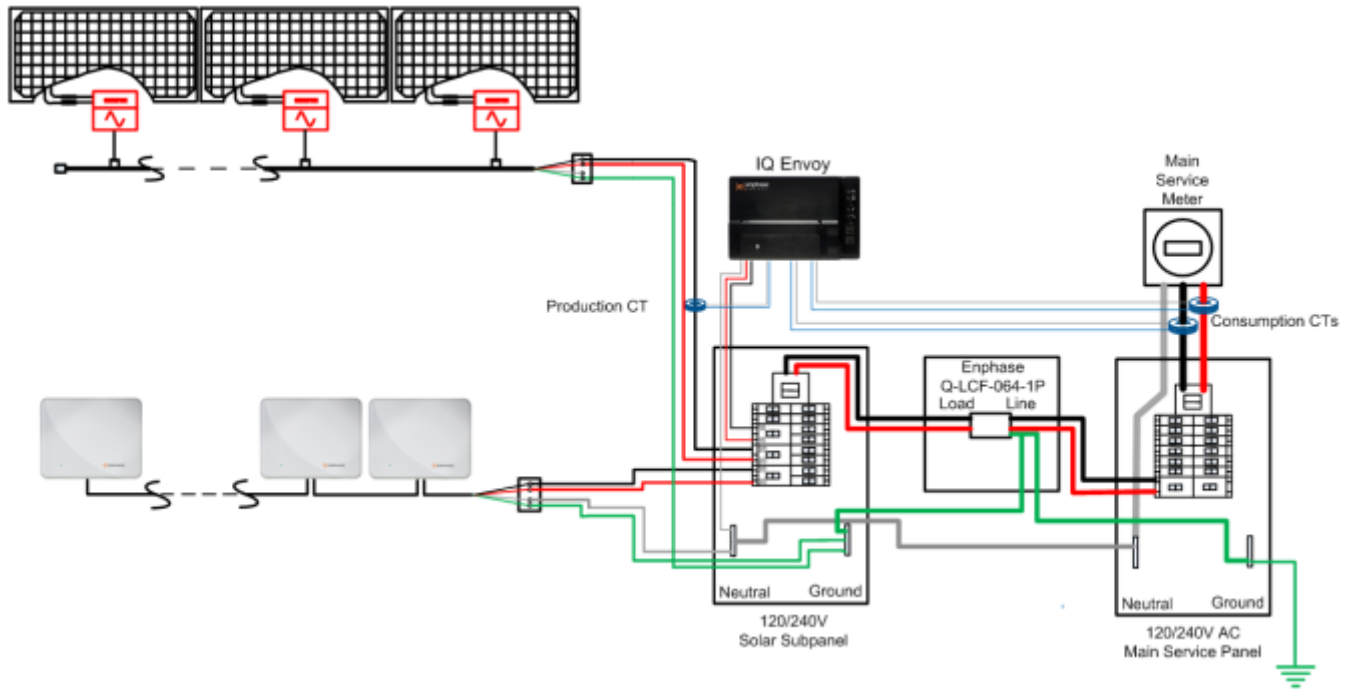

**Mechanicals of Q-LCF-064 Filter (all dimensions in mm)**

