

Integrated Lithium-ion Battery Pack for Wall-Mounted User Manual



ProductName: 48V100Ah LithiumBattery

ProductModel: SG48100M

ProductSpecifications: 51.2V100Ah

Catalogue

1. Document description	3
2. Definition of Terms	3
3. Battery system performance parameters	3
4. Outline and Structural Dimensions of Battery System	5
5. Definition of battery system interface	6
5.1. Panel Schematic	6
5.2. Module Panel Description	6
6. Functional block diagram	7
7. Battery Management System Specifications	7
7.1. Basic parameter settings	7
7.2. Interface	10
7.2.1. Interface diagram	10
7.2.2. Interface Definition	11
7.3. Communication description	11
7.3.1. RS232 communication	11
7.3.2. RS485 communication	12
7.3.3. CAN communication	12
8. Product function and performance description	13
8.1. Charging performance	13
8.2. Discharging performance	13
9. Using & Maintenance Suggestions	14
9.1. LED indication description	14
9.2. Buzzer action description	15
9.3. Key Description	15
9.4. Sleep and wake up	16
9.4.1. hibernate	16
9.4.2. Wake	16
9.5. DIP switch settings	16
9.6. The routine maintenance of the battery part can be carried out by referring to the table	18
10. Packing List	18
11. Storage, maintenance and transportation	19
11.1. Storage	19
11.2. Transportation	19
12. Maintain	19
13. Battery usage precautions	20
14. Product Liability	20

1. Document description

This specification covers the performance indexes, technical requirements and safety issue of the 48V100Ah

2. Definition of Terms

BMS	Battery Management System
DOD	Depth Of Discharge
EOL	End Of Life
OCV	Open Circuit Voltage
SOC	State Of Charge
SOH	State Of Health
EMC	Electro Magnetic Compatibility
Nominal voltage	Appropriate voltage approximation to identify or identify a cell or an electrochemical system.
Capacity	(The amount of power a battery can provide when fully charged under specified conditions. Usually expressed in Ah.)
Energy	The energy that can be provided by a fully charged battery under specified conditions. Usually expressed in Wh or kWh.
Unit	“V” (Volt) (Voltage unit) “A” (Ampere) (Current unit) “Ah” (Ampere-Hour) (unit of charge) “Wh” (Watt-Hour) (electrical energy unit) “Ω” (Ohm) (resistance unit) “ °C” (degree Celsius) (temperature unit) “mm” (millimetre) (length unit) “s” (second) (Time unit) “kg” (kilogram) (Weight unit) “Hz” (Hertz) (Frequency unit)

3. Battery system performance parameters

No.	Item	Technical parameter	Note
1	Battery Type	Lithium iron phosphate battery	/
2	Rated capacity	100Ah	@25°C±2, 0.5C, 100%DOD
3	Nominal voltage	51.2V	
4	Recommended charging voltage	54.5V	
5	Charging Limited Voltage	57.6V	
6	SOC working range	0~100%	Recommended range of use: 20%~95%
7	Standard discharge current	50A	

8	Maximum continuous discharge current	100A	
9	Standard charging current	50A	
10	Maximum continuous charge current	100A	
11	Maximum cut-off voltage for charging	57.6V	
12	Charge cut-off current	5A	0.05C magnification
13	Discharge cut-off voltage	43.2V	
14	PACK cycle life	≥7000	80% DOD 25°C±2°C, 0.5C charge/0.5C discharge
15	Thermal management method	Natural heat dissipation	
16	IP protection class	IP55 battery box	
17	Flammability rating	plastic parts UL94 V-0	
18	Total system mass	Around 43KG	
19	Battery system shell material	299U Q235A	Color can be customized
20	Shipping SOC	SOC45-55%	
21	Dimension (L*W*H mm)	☑420*580*140mm±2mm	
22	Design life	15 Year	
23	Parallel function	Supports up to 6 3 batteries in parallel	
24	Display function	English smart display	
25	Charging current limit function	Current limit 20A	Charging current limit can be set according to customer requirements
26	Communication mode	☑RS232	Communication mode can be set according to customer requirements
		☑RS485	
		☑CAN	
27	Communication protocol	Support multiple protocols	Communication protocol can be set according to customer requirements
28	Storage ambient temperature	-10~+45°C	Recommended storage temperature: 0~+30°C
29	Working temperature	Battery charging:0~ 45°C Battery discharging:-20~ +60°C	
30	Relative humidity of working environment	≤95	Best Use Relative Humidity: ≤85%

4. Outline and Structural Dimensions of Battery System

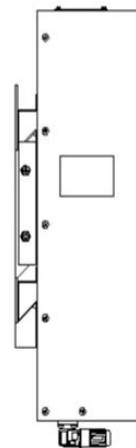
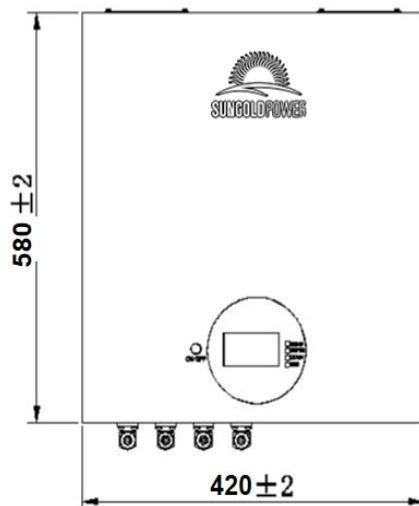
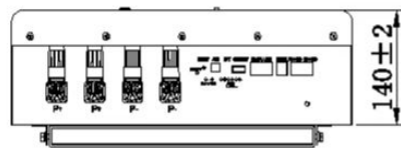
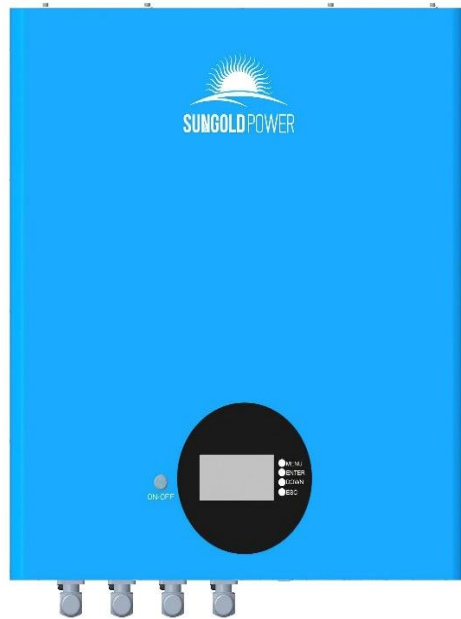

5. Definition of battery system interface

5.1. Panel Schematic

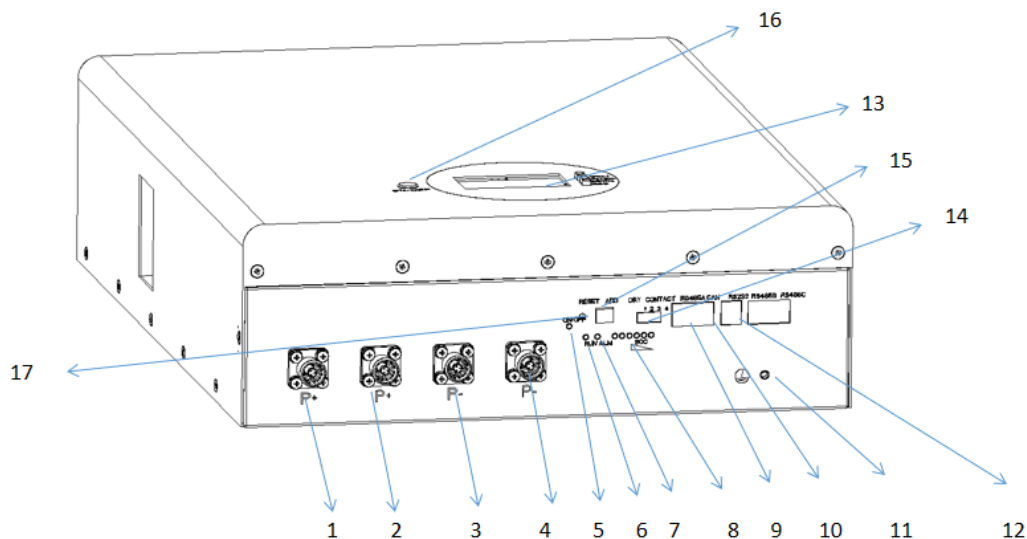

5.2. Module Panel Description

1. P+	2. P+	3. P-	4.P-	5. ON/OFF	6.RUN
7. ALM	8. SOC	9. RS485	10. CAN	11.GROUND SCREW	12.RS232
13.DISplay	14. DRY CONTACT	15.ADD	16.SWITCH	17. REWET	

6. Functional block diagram

The functional block diagram is shown in the figure below

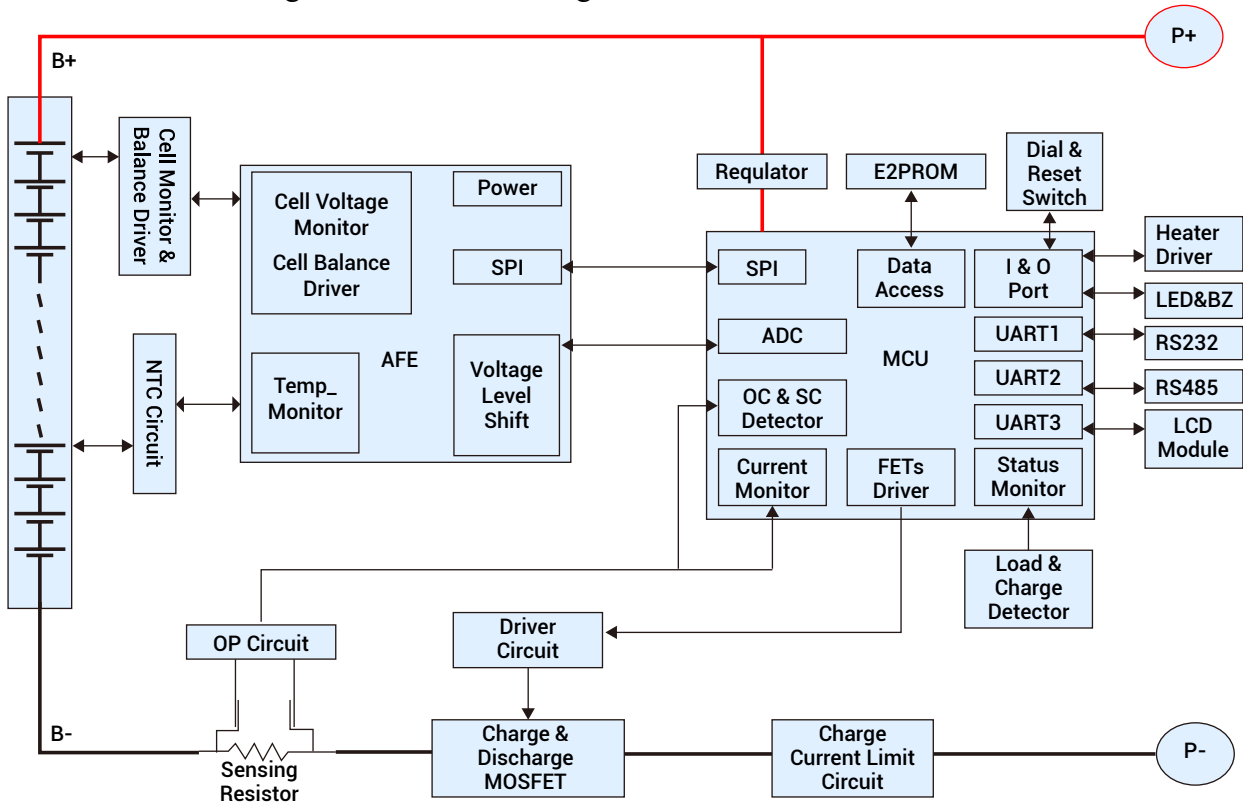

7. Battery Management System Specifications

7.1. Basic parameter settings

NO.	Indicator item		Factory default parameters	Is it possible to set	Note
1	Cell overcharge protection	Cell overcharge alarm voltage	3600mV	Can be set	
		Cell overcharge protection voltage	3700mV	Can be set	
		Cell overcharge protection delay	4.0S	Can be set	
	Single Overvoltage Protection Released	overcharge protection release voltage Cell	3380mV	Can be set	
		Capacity release	SOC<96%	Can be set	
		Discharge release	> 2A		
2	Cell overdischarge protection	Cell over-discharge alarm voltage()	2700mV	Can be set	After 30 seconds of over-discharge protection, if it still cannot recover, it will enter low power consumption mode
		Cell over-discharge protection voltage	2500mV	Can be set	
		Monomer over-discharge protection delay	1.0S	Can be set	
	Cell over-discharge protection released	Cell over-discharge protection release voltage	2800mV	Can be set	
		(Release when charging)	Plug into the charger to activate		

3	Overall overcharge protection	Overall overcharge warning voltage	57.6V	Can be set	
		Overall overcharge protection voltage	58.4V	Can be set	
		Overall overcharge protection delay	1.0S	Can be set	
	Overall overvoltage protection released	Overall overcharge protection release voltage	54.1V	Can be set	
		Capacity release	SOC < 96%	Can be set	
		Discharge release	> 2A		
4	Overall overdischarge protection	Overall over-discharge warning voltage	43.2V	Can be set	After 30 seconds of over-discharge protection, if it still cannot recover, it will enter low power consumption mode
		Overall over-discharge protection voltage	40V	Can be set	
		Overall over-discharge protection delay	1.0S	Can be set	
	Overall over-discharge protection released	Overall over-discharge protection release voltage	44.8V	Can be set	
		Release when charging	Plug into the charger to activate		
	Charging current limit function	Charging current limit	20A		
5	Charge overcurrent protection	Charge overcurrent 1 alarm current	105A	Can be set	Appearing 10 times in a row will lock the status and will no longer automatically release
		Charge overcurrent 1 protection current	110A	Can be set	
		Charge overcurrent 1 protection delay	1.0S	Can be set	
	Charging overcurrent 1 protection released	Automatic release)	1min Automatically cancel after 1min		
		Discharge release	> 1A Discharge current > 1A		
6	Discharge overcurrent 1 protection	Discharge overcurrent 1 alarm current)	105A	Can be set	Appearing 10 times in a row will lock the status and will no longer automatically release
		Discharge overcurrent 1 protection current)	110A	Can be set	
		Discharge overcurrent 1 protection delay	1.0S	Can be set	
	Discharge overcurrent 1 protection released	Automatic release	1min Automatically cancel after 1min		
		Charge release	> 1A Charge current > 1A		
7	Discharge overcurrent 2	Discharge overcurrent 2 protection current	≥120A	Can be set	Appearing 10 times in a row will lock the status and will no longer automatically release
		Discharge overcurrent 2 protection delay	100mS	Can be set	
	Discharge overcurrent 2 protection released	Automatic release	1min Automatically cancel after 1min		
		charge release	> 1A Charge current > 1A		
8	Short circuit	Short circuit protection function		(Have)	

	protection	Short circuit protection current	/		
		Short circuit protection delay	/		
		Short circuit protection released	When there is charging, the short circuit protection is released After the load is removed, it will automatically disarm		
9	MOS high temperature protection	MOS over temperature alarm temperature)	90°C	Can be set	
		MOS over temperature protection temperature)	115°C	Can be set	
		MOS protection release temperature)	85°C	Can be set	
10	Cell temperature protection	Charging low temperature warning temperature)	0°C	Can be set	
		Charging low temperature protection temperature)	-5°C	Can be set	
		Charging low temperature protection release temperature	0°C	Can be set	
		Charging high temperature alarm temperature	55°C	Can be set	
		Charging high temperature protection temperature)	60°C	Can be set	
		Charging high temperature protection release temperature	50°C	Can be set	
		Discharge low temperature alarm temperature	-15°C	Can be set	
		Discharge low temperature protection temperature	-20°C	Can be set	
		(Discharge low temperature protection release temperature	-15°C	Can be set	
		Discharge high temperature alarm temperature	60°C	Can be set	
		Discharge high temperature protection temperature	65°C	Can be set	
Discharge high temperature protection release temperature	55°C	Can be set			
11	Ambient temperature alarm	Ambient low temperature alarm temperature	-15°C	Can be set	
		Ambient low temperature protection temperature	-20°C	Can be set	
		Ambient cryogenic protection release temperature	-15°C	Can be set	
		Ambient high temperature alarm temperature	60°C	Can be set	
		Ambient high temperature protection temperature	65°C	Can be set	
		Ambient high temperature protection release temperature	55°C	Can be set	
12	Current consumption	Self-consumption current during operation	≤55mA ((with display) ≤45mA(without display)		
		Low power mode current	≤200μA		

13	Equalization function	Equalization turn-on voltage	3500mV	Can be set	
		Open differential pressure	30mV	Can be set	
14	Capacity default settings	Low battery warning	SOC<5%	Can be set	(No alarm when charging)
		Full capacity setting	100AH	Can be set	
15	Sleep function	Sleep voltage	3150mV	Can be set	
		Delay	5min	Can be set	
16	Cell failure protection	Monomer differential pressure	>1V Voltage difference>1V		Charge and discharge are not allowed
17	Full charge judgment	Full charge voltage	56V		
		Cut off current	2A		

7.2. Interface

7.2.1. Interface diagram

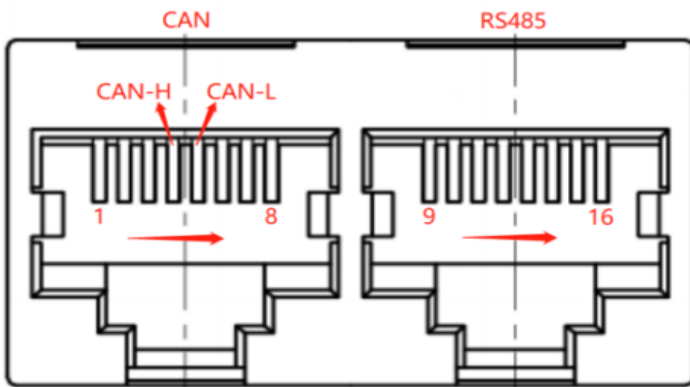

CAN and RS485 interface

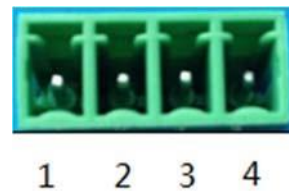

dry contact

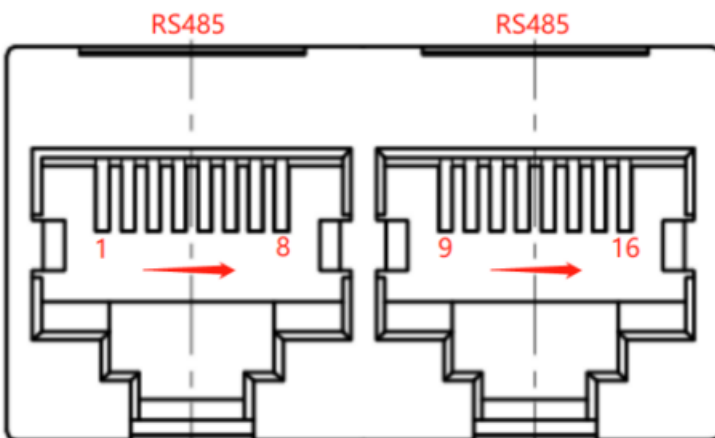

Parallel communication port

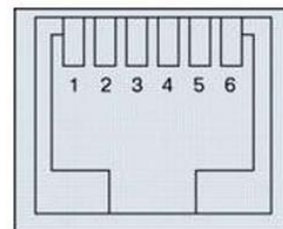

RS232 communication interface

7.2.2. Interface Definition

RS232--Using 6P6C vertical RJ11 socket	
RJ11	Definition description
2	NC
3	TX
4	RX
5	GND

RS485 and CAN interface

RS485--Using 8P8C vertical RJ45 socket		CAN--Using 8P8C vertical RJ45 socket	
RJ45 Pin	Definition description	RJ45 Pin	Definition description
9、 16	RS485-B1	1、 3、 6、 7、 8	NC
10、 15	RS485-A1	4	CAN-H
11、 14	GND	5	CAN-L
12、 13	NC	2	GND

Parallel communication port

RS485--Using 8P8C vertical RJ45 socket		RS485--Using 8P8C vertical RJ45 socket	
RJ45Pin	Definition description	RJ45 Pin	Definition description
1、 8	RS485-B	9、 16	RS485-B
2、 7	RS485-A	10、 15	RS485-A
3、 6	GND	11、 14	GND
4、 5	NC	12、 13	NC

7.3. Communication description

7.3.1. RS232 communication

The BMS can communicate with the host computer through the RS232 interface, so as to monitor

various information of the battery on the host computer side, including battery voltage, current, temperature, status, SOC, SOH and battery production information, etc. The default baud rate is 9600bps.

7.3.2. RS485 communication

With dual RS485 interface, you can view the information of PACK, the default baud rate is 9600bps. To communicate with the monitoring device through RS485, the monitoring device is used as the host to poll data according to the address, and the address setting range is 2~63

7.3.3. CAN communication

CAN communication, baud rate 500K

8. Product function and performance description

8.1. Charging performance

- ◆ Standard charging current (25°C) : example:0.5C (50A)
- ◆ Standard charging voltage: 57.6V
- ◆ Standard charging mode and charging curve:

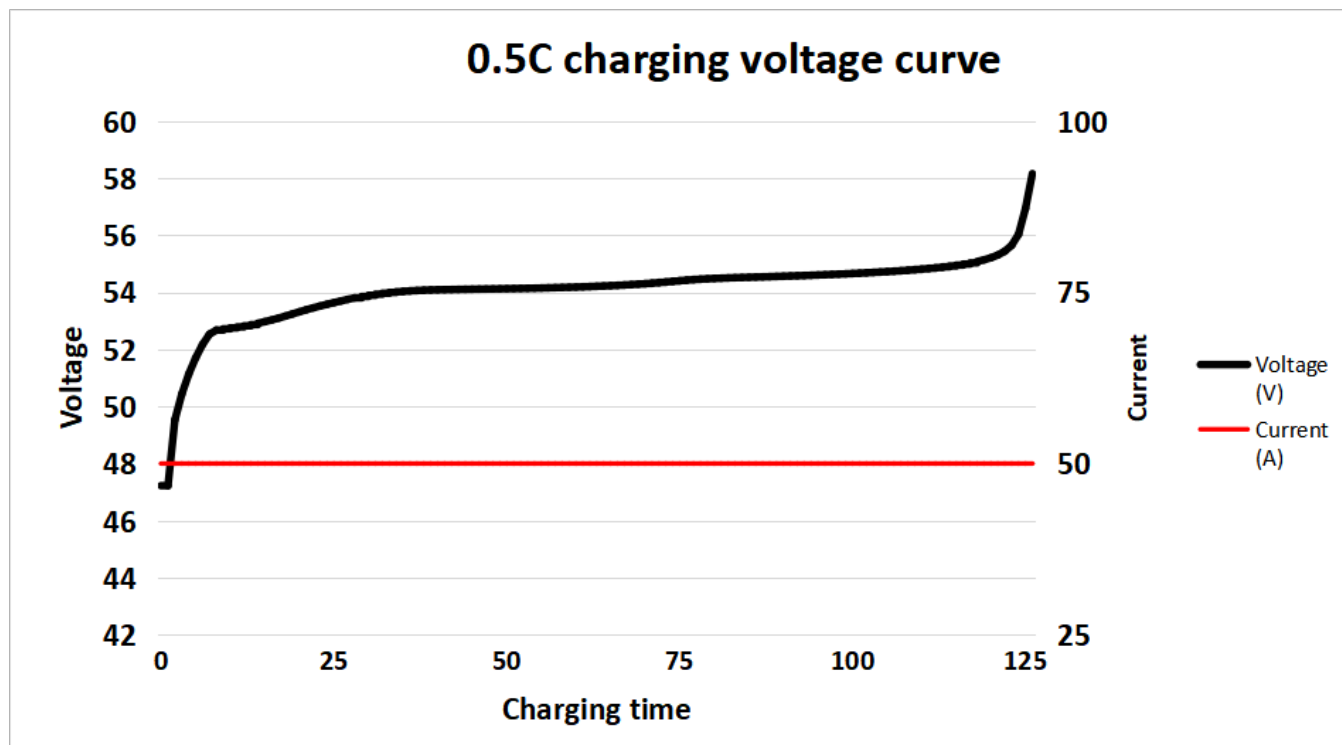

8.2. Discharging performance

Discharge curve at different magnification

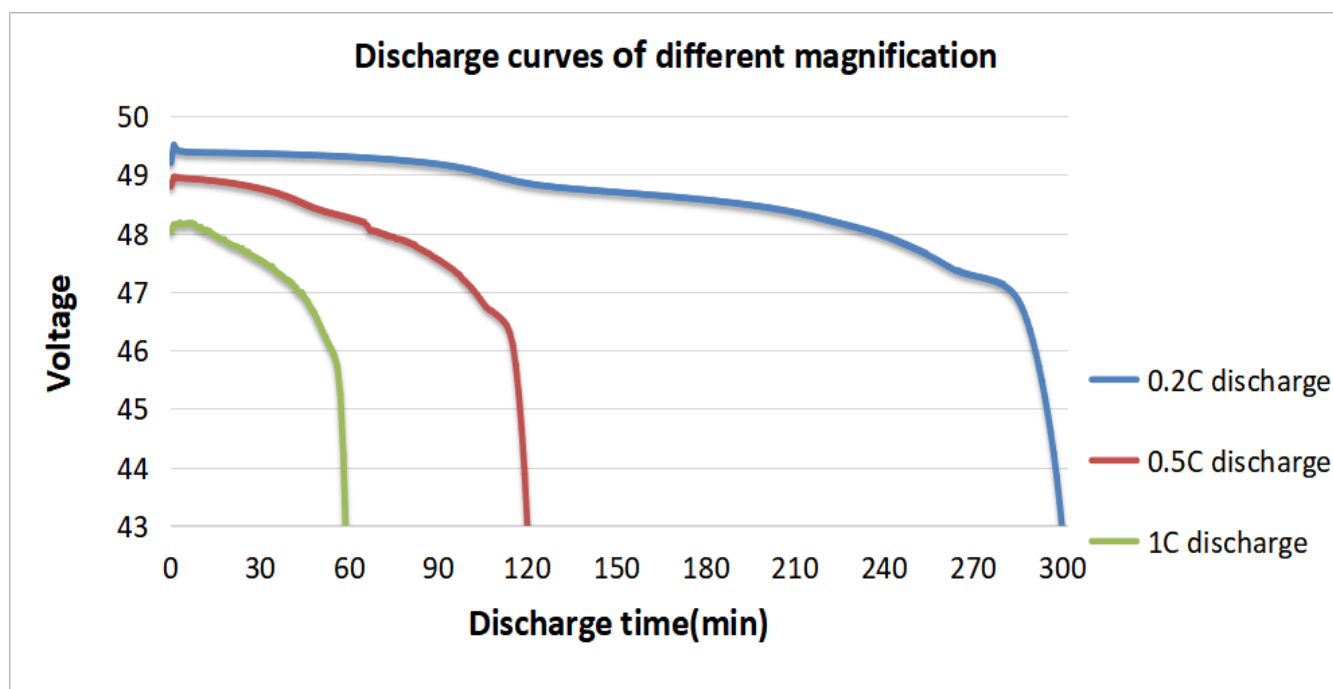

9. Using & Maintenance Suggestions

9.1. LED indication description

Table 1 LED working status indication

Condition	Normal /Alarm/ Protect	RUN	ALM	LED Battery indicator LED						Illustrate	
		●	●	●	●	●	●	●	●		
Shutdown	Hibernate	black	black	black	black	black	black	black	black	black	Annihilate
Standby	Normal	flash1	black	According to the battery indicator						Standby mode	
	Alarm	flash1)	flash3							Module low voltage	
Charging	Normal	Always bright)	black	According to the battery indicator (battery indication maximum LED flashes 2)						(The highest power LED flashes (flashing 2), the overcharge alarm ALM does not flash)	
	Alarm	Always bright	3 flash3								
	Overcharge protection	Always bright	black	Always bright	Always bright	Always bright	Always bright	Always bright	Always bright	Always bright	(If there is no utility power, the indicator light is in standby state)
	Temperature, overcurrent, fail safe	black	Always bright	black	black	black	black	black	black	black	Stop charging
Discharging	Normal	flash3	black	(According to the battery indicator)							
	Alarm	flash3)	flash3								
	Undervoltage protection	black	black	black	black	black	black	black	black	black	Stop discharge
	Temperature, overcurrent, short circuit, reverse connection, fail safe	black	Always bright	black	black	black	black	black	black	black	Stop discharge
Invalid		black	Always bright	black	black	black	black	black	black	black	Stop charging and discharging

Table 2 Description of capacity indication

Condition	Charging							Discharging					
	L6●	L5●	L4●	L3●	L2●	L1●	L6●	L5●	L4●	L3●	L2●	L1●	
Electricity (%)	0~17%	black	black	black	black	black	flash2	black	black	black	black	black	Always bright
	17~33%	black	black	black	black	flash 2	Always bright	black	black	black	black	Always bright	Always bright
	33~50%	black	black	black	flash 2	Always bright	Always bright	black	black	black	Always bright	Always bright	Always bright

	50~66%	black	black	flash 2	Always s bright	Always s bright	Always bright	black	black	Always s bright	Always s bright	Always bright	Always bright
	66-83%	black	flash 2	Always s bright	Always s bright	Always s bright	Always bright	black	Always s bright	Always s bright	Always s bright	Always bright	Always bright
	83-100%	flash 2	Always s bright	Always s bright	Always s bright	Always s bright	Always bright	Always s bright	Always s bright	Always s bright	Always s bright	Always bright	Always bright
Running lights●			Always bright							flash3			

Table 3 LED flashing description

Flashing method	Bright	Black
flash 1	0.25S	3.75S
flash 2	0.5S	0.5S
flash 3	0.5S	1.5S

Note:

The LED indicator alarm can be enabled or disabled through the host computer, and the factory default is enabled.

9.2. Buzzer action description

- 1) In case of failure, it will beep for 0.25S every 1S;
- 2) During protection, it will beep for 0.25S every 2S (except for overvoltage protection);
- 3) When alarming, it will beep every 3S for 0.25S (except overvoltage alarm);
- 4) The buzzer function can be enabled or disabled by the host computer, and the factory default is disabled.

9.3. Key Description

- 1)When the BMS is in the dormant state, press the button (3~6S) and release it, the protection board will be activated, and the LED indicators will light up in sequence from "RUN" for 0.5 seconds.
- 2)When the BMS is activated, press the button (3~6S) and release it, the protection board is put to sleep, and the LED indicators light up sequentially for 0.5 seconds from the lowest battery light.
- 3)When the BMS is activated, press the button (6~10S) and release it, the protection board will be reset, and all the LED lights will light up at the same time for 1.5 seconds.

After the BMS is reset, it still retains the parameters and functions set by the host computer. If it is necessary to restore the initial parameters, it can be achieved through the "restore default value" of the host computer, but the relevant operation records and stored data remain unchanged (such as power, cycle times, etc.). , protection records, etc.).

9.4. Sleep and wake up

9.4.1. hibernate

When any of the following conditions are met, the system enters a low-power mode:

1. The single or overall over-discharge protection has not been released within 30 seconds.
2. Release the button after pressing the button for 3 seconds.
3. The minimum cell voltage is lower than the sleep voltage, and the duration reaches the sleep delay time (at the same time, no communication, no protection, no balance, and no current are satisfied).
4. The standby time is more than 24 hours (no communication, no charging and discharging, no mains power).
5. Forced shutdown through the host computer software. Before entering the sleep mode, make sure that the input terminal is not connected to an external voltage, otherwise it will not be able to enter the low power consumption mode.

9.4.2. wake

When the system is in low-power mode and meets any of the following conditions, the system will exit the low-power mode and enter the normal operation mode:

1. Connect the charger, the output voltage of the charger must be greater than 48V.
2. Press the button for 3S and release the button.
3. Connect to the communication line and open the software of the upper computer (it enters the sleep state due to over-discharge protection, this method cannot wake up the protection board).

Remarks:

After the single or overall over-discharge protection, it enters the low-power mode, wakes up regularly every 4 hours, and turns on the charge and discharge MOS. If it can be charged, it will exit the dormant state and enter normal charging; if it cannot be charged after 10 consecutive automatic wake-ups, it will no longer automatically wake up.

When the system is defined as the end of charging, the recovery voltage is not reached after 2 days of standby (standby time setting value), and the charging is forced to resume until the end of charging again.

9.5. DIP switch settings

When the battery packs are used in parallel, different PACK can be distinguished by their hardware addresses, and the hardware address of each PACK in the entire battery stack is unique. The hardware addresses can be set in sequence through the DIP switches on the board. Refer to the following for the definition of the switches. surface.

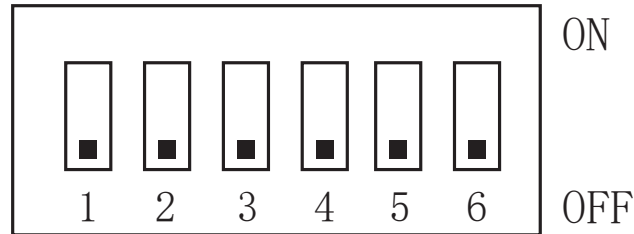

Add	Dip switch position					
	#1	#2	#3	#4	#5	#6
1	ON	OFF	OFF	OFF	OFF	OFF
2	OFF	ON	OFF	OFF	OFF	OFF
3	ON	ON	OFF	OFF	OFF	OFF
4	OFF	OFF	ON	OFF	OFF	OFF
5	ON	OFF	ON	OFF	OFF	OFF
6	OFF	ON	ON	OFF	OFF	OFF
7	ON	ON	ON	OFF	OFF	OFF
8	OFF	OFF	OFF	ON	OFF	OFF
9	ON	OFF	OFF	ON	OFF	OFF
10	OFF	ON	OFF	ON	OFF	OFF
11	ON	ON	OFF	ON	OFF	OFF
12	OFF	OFF	ON	ON	OFF	OFF
13	ON	OFF	ON	ON	OFF	OFF
14	OFF	ON	ON	ON	OFF	OFF
15	ON	ON	ON	ON	OFF	OFF
16	OFF	OFF	OFF	OFF	ON	OFF
17	ON	OFF	OFF	OFF	ON	OFF
18	OFF	ON	OFF	OFF	ON	OFF
19	ON	ON	OFF	OFF	ON	OFF
20	OFF	OFF	ON	OFF	ON	OFF
21	ON	OFF	ON	OFF	ON	OFF

22	OFF	ON	ON	OFF	ON	OFF
23	ON	ON	ON	OFF	ON	OFF
24	OFF	OFF	OFF	ON	ON	OFF
25	ON	OFF	OFF	ON	ON	OFF
26	OFF	ON	OFF	ON	ON	OFF
27	ON	ON	OFF	ON	ON	OFF
28	OFF	OFF	ON	ON	ON	OFF
29	ON	OFF	ON	ON	ON	OFF
30	OFF	ON	ON	ON	ON	OFF
31	ON	ON	ON	ON	ON	OFF
32	OFF	OFF	OFF	OFF	OFF	ON
33	ON	OFF	OFF	OFF	OFF	ON
34	OFF	ON	OFF	OFF	OFF	ON
35	ON	ON	OFF	OFF	OFF	ON
36	OFF	OFF	ON	OFF	OFF	ON
37	ON	OFF	ON	OFF	OFF	ON
38	OFF	ON	ON	OFF	OFF	ON
39	ON	ON	ON	OFF	OFF	ON
40	OFF	OFF	OFF	ON	OFF	ON
41	ON	OFF	OFF	ON	OFF	ON
42	OFF	ON	OFF	ON	OFF	ON
43	ON	ON	OFF	ON	OFF	ON
44	OFF	OFF	ON	ON	OFF	ON
45	ON	OFF	ON	ON	OFF	ON
46	OFF	ON	ON	ON	OFF	ON
47	ON	ON	ON	ON	OFF	ON
48	OFF	OFF	OFF	OFF	ON	ON
49	ON	OFF	OFF	OFF	ON	ON
50	OFF	ON	OFF	OFF	ON	ON
51	ON	ON	OFF	OFF	ON	ON
52	OFF	OFF	ON	OFF	ON	ON
53	ON	OFF	ON	OFF	ON	ON
54	OFF	ON	ON	OFF	ON	ON
55	ON	ON	ON	OFF	ON	ON
56	OFF	OFF	OFF	ON	ON	ON
57	ON	OFF	OFF	ON	ON	ON
58	OFF	ON	OFF	ON	ON	ON
59	ON	ON	OFF	ON	ON	ON
60	OFF	OFF	ON	ON	ON	ON
61	ON	OFF	ON	ON	ON	ON
62	OFF	ON	ON	ON	ON	ON
63	ON	ON	ON	ON	ON	ON

9.6. The routine maintenance of the battery part can be carried out by referring to the table

Period	Item	Treatment measures
Per month	(Operating environment)	Keep away from heat sources and avoid direct sunlight
	Visual inspection	If the appearance is damaged, leaked or deformed, the faulty battery pack should be disconnected, photographed and replaced.
Each quarter	Clean appearance	Clean the exterior with a cotton cloth. Due to the high voltage of the battery pack, care should be taken when cleaning.
	Connection Status	<ul style="list-style-type: none"> ● Check the bolts at each terminal and retighten them if they are loose. ● If the temperature of the connection line exceeds 40°C (feeling hot), check the cause
Every half year	Voltage detection	<ul style="list-style-type: none"> ● At the end of charging, measure and record the busbar voltage and the positive and negative terminal voltages of the battery pack. The voltages of the two are consistent. Otherwise, check whether the cable at the corresponding connection is faulty. ● In the first year, real-time data collection at the end of discharge was performed at least every six months. ● Beginning in the second year, on-site capacity determination will be conducted every three months. If a certain battery cell is frequently overcharged and over-discharged in the historical alarm information viewed through the RS232 interface, it means that the battery cell has touched the charging protection point and the discharging protection point for a long time. This situation may lead to insufficient backup time, it is recommended to replace it in time

The final state of charge and discharge can be judged by the capacity light, refer to the definition of LED light capacity status light.

10. Packing List

See below for packing list

NO.	Material name	Specification/Module	Number
1	48100Ah lithium iron phosphate battery	48100	1 set/box
2	Positive and negative output lines	One end crimped 25-8, one end waterproof plug, 25mm ² flame retardant cable, 1500mm long one red and one black.	1 set/1 module
3	RS485 cascade communication line	1.5 meters long, with RJ45 crystal heads at both ends.	1root/1 modules
4	RS232 USB	1.2 meters long, one end is the corresponding crystal head, and the other end is the USB interface.	optional
5	Product manual	/	1
6	Certificate	/	1
7	Wall bracket and supporting M10 expansion bolt	Wall bracket and supporting M10 expansion bolt	1 set

8	M6 * 12 composite bolt	M6 * 12 composite bolt	4pc
9	Dry contact terminal	Matching according to the number of dry nodes of the BMS	1pc

11.Storage, maintenance and transportation

11.1. Storage

1. The battery pack is usually stored at a state of charge of 20% to 40% in a clean, dry, ventilated and rain-proof room with an ambient temperature of -5°C to 35°C and a relative humidity of not more than 75%, and should be placed flat. Pad height, not less than 100MM from the ground;
2. Batteries cannot be stored with active chemicals or dusting items;
3. The battery cannot be subjected to any mechanical shock or heavy pressure;
4. The battery should avoid direct sunlight, keep away from the fire source, and the distance from the heat source should not be less than 2M;
5. From the date of manufacture, every 3 months of storage should be charged with a current of 0.2~0.5C for 30~60min, and the temperature range is 25°C±5°C.5) .

11.2. Transportation

The battery pack should be packaged and shipped. During transportation, avoid severe vibration, shock or extrusion, and avoid sun and rain. Batteries can be transported by vehicles such as cars, trains, ships, and planes.

12. Maintain

The battery pack should remain at 40% - 60% of state of charge;

When the battery is not in use for a long time, it is recommended to charge it with 0.2c current every three months or so.

During the maintenance process, do not install or remove the battery in the battery pack by yourself, otherwise the battery performance will be reduced;

Any battery in the battery pack shall not be disassembled or replaced without authorization, and dissection of the battery is strictly prohibited.

13. Battery usage precautions

Please read the instruction manual and precautions carefully before use. When used correctly according to the product characteristics, the battery will be a safe, reliable and convenient storage battery.

Warn! Improper use of lithium-ion batteries can result in personal injury or fire!

1. When charging the battery, pay attention to ensure that the polarity is correct, and do not reverse the charging of the battery;
2. Do not expose the battery to adverse environments, such as extreme temperatures, deep cycling, frequent overcharge/overdischarge;
3. If you find that the battery is abnormal, please stop using it immediately and report it to a professional for treatment;
4. Ensure that batteries and battery management systems are kept away from dangerous goods or dangerous materials;
5. It is forbidden to short-circuit the battery;
6. It is forbidden to burn or destroy the battery, which may cause the release or burning of harmful gases;
7. Do not disassemble, squeeze, pierce or burn.
8. Rain is prohibited;
9. It is forbidden to be directly exposed to sunlight;
10. Prohibit exposure to temperatures above 60°C;
11. It is forbidden to discard the battery in the garbage;
12. It is forbidden to use other types of batteries in series or in parallel with lithium-ion batteries;
13. It is forbidden to use new and old batteries (groups) in series or in parallel.

14. Product Liability

Consumers must strictly abide by the requirements of this product specification to use this product. Misuse may lead to serious accidents. The company is not responsible for any accidents caused by the operation and use that are not strictly in accordance with this product specification. The company reserves the right to change the contents of this specification without prior notice; the final interpretation right of this information belongs to the company.