

AES RACKMOUNT

Energy Storage System

AES RACKMOUNT INSTALLATION AND OPERATION MANUAL

BATTERY MODELS

48-48-5120		900-0062
48-48-5120-H		900-0067



INTRODUCTION	3
1. AUDIENCE, MESSAGES, WARNINGS, GENERAL SAFETY, PERSONAL PROTECTIVE EQUIPMENT . . .	3
1.1 Audience.	3
1.2 Warning, Caution, Notice, and Note Messages.	3
1.3 General Warnings	4
1.4 Safe Handling Procedures.	5
1.5 Personal Protective Equipment.	6
2. ITEMS SHIPPED IN THE BOX.	6
3. SPECIFICATIONS	7
3.1 Electrical Specifications.	7
3.2 Mechanical Specifications.	8
3.3 Environmental Specifications.	9
3.4 Protections Specifications.	9
3.5 Internal Heating Specifications.	11
3.6 Minimum Specifications for Battery Module Systems.	11
3.7 Regulatory	12
4. TRANSPORTATION	13
5. HANDLING	13
6. FEATURES	14
6.1 Battery Module Breaker.	14
6.2 Battery Module ON/OFF Key.	15
6.3 At-a-glance LED	15
6.4 LYNK Port	16
6.5 Equipment Ground	16
7. THEORY OF OPERATION	17
7.1 Ingress Protection IP20	17
7.2 Internal Heating (48-48-5120-H)	17
7.3 Battery Management System	18
7.4 LYNK Network Communication	19
8. OPTIONAL ACCESSORIES	20
9. INSTALLATION	20
9.1 Tools	21
9.2 Location	21
9.3 DC Cables	22
9.4 DC Protection	23
9.5 Terminal Connections and Hardware.	23
9.6 Single Battery Module Installation Procedure.	24
9.7 Parallel Battery Module Installation Procedure	26
9.8 LYNK Network	28
10. OPERATION	29
10.1 Low Voltage Cut-Off.	29
10.2 State of Charge	29
10.3 Charging.	30
10.4 Charging Profile.	31
11. ROUTINE INSPECTION	33
12. STORAGE	34
13. BATTERY MODULE FIRMWARE AND DATA LOGS	34
14. TROUBLESHOOTING	35
15. RELATED INFORMATION	35
16. GLOSSARY OF TERMS, ABBREVIATIONS, AND ACRONYMS	35

Introduction

The AES RACKMOUNT is a battery module that can operate independently or in a battery bank configuration where multiple battery modules are connected in parallel.

1. AUDIENCE, MESSAGES, WARNINGS, GENERAL SAFETY, PERSONAL PROTECTIVE EQUIPMENT

1.1 Audience

Configuration, installation, service, and operating tasks should only be performed by qualified personnel in consultation with local authorities having jurisdiction and authorized dealers. Qualified personnel should have training, knowledge, and experience in:

- Installing electrical equipment
- Applying applicable installation codes
- Analyzing and reducing hazards involved in performing electrical work
- Installing and configuring batteries
- Installing and configuring systems activated by relays

1.2 Warning, Caution, Notice, and Note Messages

Messages in this manual are formatted according to this structure.



Additional information concerning important procedures and features of the product. Read all the instructions before installation, operation, and maintenance.



Important information regarding hazardous conditions.

⚠ WARNING

Important information regarding hazardous conditions that may result in personal injury or death.

⚠ CAUTION

Important information regarding hazardous conditions that may result in personal injury.

NOTICE

Important information regarding conditions that may damage the equipment but not result in personal injury.

NOTE

Ad hoc information concerning important procedures and features unrelated to personal injury or equipment damage.

1.3 General Warnings



Do not crush, disassemble or dispose of the battery module in fire or the garbage.



This product is made of recyclable materials and must be recycled.



⚠ WARNING

ELECTRIC SHOCK AND FIRE HAZARD

- This equipment must only be installed as specified.
- Connect the battery to isolated Power Conversion Systems (PCS) only.
- Do not install the battery module in series.
- Do not disassemble or modify the battery module.
- If there is damage to the battery module case, do not touch exposed contents.
- There are no user-serviceable parts inside.

Failure to follow these instructions may result in death or serious injury.

⚠ WARNING

CHEMICAL HAZARD

Do not touch the exposed contents of a Lithium cell.

Failure to follow these instructions may result in death or serious injury.

⚠ WARNING

ELECTRIC SHOCK AND FIRE HAZARD

Do not lay tools or other metal parts across the terminals.

Failure to follow these instructions may result in death or serious injury.

⚠ CAUTION

HEAVY OBJECT

Two-person lift is recommended for the battery module.

Failure to follow these instructions may result in injury.

CAUTION

ELECTRIC SHOCK HAZARD

- Do not touch the energized surfaces of any electrical component in the battery module system.
- Before servicing the battery module, follow all procedures to fully de-energize the battery module system.
- Follow the “Safe Handling Procedures” below when working with the battery module.

Failure to follow these instructions may result in injury.

1.4 Safe Handling Procedures

Before using the battery module, read all instructions and cautionary markings on the unit and all appropriate sections of this manual.

- Use personal protective equipment when working with battery modules.
- Do not dispose of the battery module in a fire.
- Promptly dispose of or recycle used battery modules following local regulations.
- Do not disassemble, open, crush, bend, deform, puncture or shred.
- Do not modify, re-manufacture, or attempt to insert foreign objects into the battery module, immerse or expose the battery module to water or other liquids, fire, explosion, or other hazards. If the user suspects damage to the battery module due to water, heat, or other reason, take it to a service center for inspection.
- Only use the battery module for the system for which it is specified.
- Do not lift or carry the battery module while in operation.
- The battery module is heavy. When lifting the battery module, follow appropriate standards.
- Only lift, move, or mount following local regulations.
- Take care when handling battery module terminals and cabling.
- Do not expose the battery module to high temperatures.
- Do not submerge the battery module.
- Do not install the battery module with the faceplate down.
- Only use the battery module with a charging system that meets specifications. Using a battery module or charger that does not meet specifications may present a risk of fire, explosion, leakage, or other hazards.
- Do not short-circuit a battery module or allow metallic conductive objects to contact battery module terminals.
- Replace the battery module with only another battery module that meets the specifications of the system. Using a battery module that does not meet specifications may present a risk of fire, explosion, leakage, or other hazards.
- Do not drop the device or battery module. If the device or battery module is dropped, especially on a hard surface, and the user suspects damage, take it to a service center for inspection.

1.5 Personal Protective Equipment

When handling or working near a battery:

- Use Personal Protective Equipment, including clothing, glasses, insulated gloves, and boots.
- Do not wear metal rings, watches, bracelets, or necklaces.

2. ITEMS SHIPPED IN THE BOX

Table 2-1, AES RACKMOUNT box contents

Items	Description
1	Battery Module
1	CAT6 Cable (30.48 mm, 12 inch)
4	Mounting Screw (M6)
1	#6 Ground Wire (200 mm, 7.87 inch)
5	Serial Number Label
1 set	Spares: Mounting Screws M6 (2), Cage Nuts M5 (6)

3. SPECIFICATIONS

All specifications in this document are published @25°C / 77°F.

3.1 Electrical Specifications

Table 3-1, AES RACKMOUNT Electrical Specifications

Electrical Specifications	48-48-5120 900-0062 / 48-48-5120-H 900-0067
Nominal Voltage	51.2 V
Energy	5120 Wh
Capacity 1 Hr	100 Ah
Charge Bulk Voltage - Bulk Vdc	55.2 V
Charge Absorption Voltage - U1 MAX	55.2 V
Charge Float Voltage - U2	55.2 V
Charge Termination Current ^(a)	2.5 A
Low Voltage Disconnect Recommended	48.0 V
Low Voltage Disconnect ^(b)	43.2 V
Max Discharge Current (1 hour)	95 A
Max Continuous Discharge Current ^(c)	70 A
Max Charge Current (1 hour)	95 A
Max Continuous Charge Current ^(c)	70 A
Peak Discharge Current (3 seconds)	218 A RMS
Breaker (K-Curve)	Dual 100 A (2-Pole ganged)
Maximum short circuit fault current (IBF / ½ IBF)	3.8 kA (100 ms) / 1.9 kA (100 ms)
Arc Flash Incident Energy IEm	0.112 Cal/cm ²
Arc Flash Incident Energy AFB	9.4 cm
^(a) Charge termination current is permitted to be less than specified. ^(b) Low Voltage Disconnect is based on 2.7VPC under load. In no load conditions, do not allow the battery module to self-discharge below 3.0VPC. ^(c) The max "continuous" charge and discharge currents are the ratings that the battery can withstand for 2 back-to-back full charge and discharge cycles with no rest without tripping overtemperature protection at 25°C (77°F) ambient.	

NOTE

Reduce the charge termination current to increase the time available for the internal balancing function.

3.2 Mechanical Specifications

Table 3-2, AES RACKMOUNT Mechanical Specifications

Mechanical Specifications	48-48-5120 900-0062 / 48-48-5120-H 900-0067
Chemistry	LiFePO ₄
Total Length	497.3 mm (19.6 in)
Body Width	439.2 mm (17.3 in) (19U)
Front Face Width	482.6 mm (19 in)
Height	133.5 mm (5.3 in) (3U)
Terminal Connector	Amphenol SurLok Plus™ Positive (+) Red - C10-730186-200 Negative (-) Black - C10-730186-100
Weight	44.0 kg (97.0 lb)
IP Rating	IP20
Case Material	Galvanized Steel Sheet

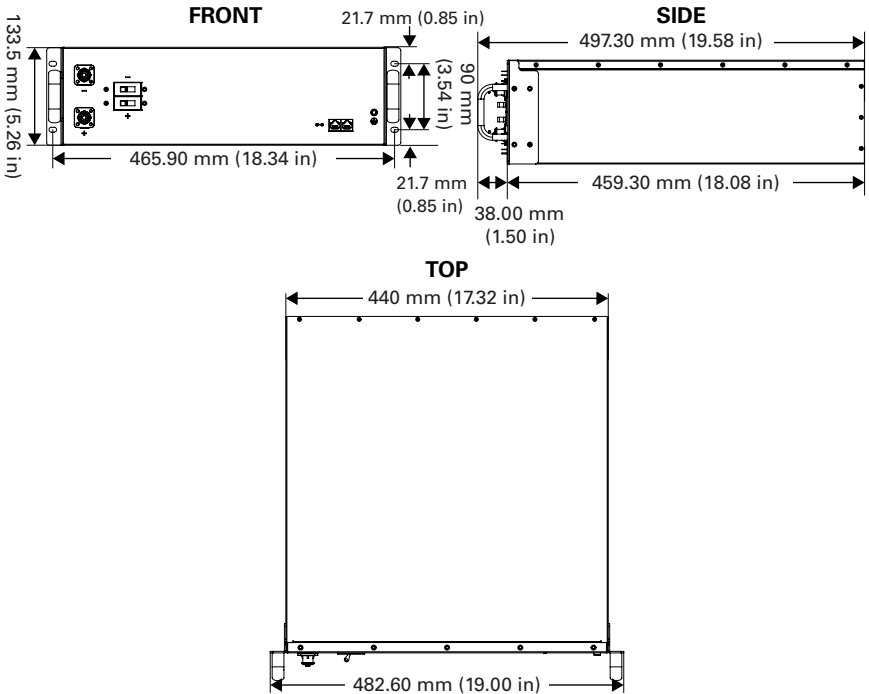

Figure 1. AES RACKMOUNT Battery Module Dimensions

3.3 Environmental Specifications

Table 3-3, AES RACKMOUNT Environmental Specifications

Environmental Specifications	48-48-5120 900-0062	48-48-5120-H 900-0067
Rated Altitude	Altitude of up to 2,000 m (6,561 ft) does not significantly affect operating characteristics	
Charge Operating Temperature Range ^{(a)(b)}	4°C to 52°C (39.2°F to 125.6°F)	
Discharge Operating Temperature Range ^(a)	-17°C to 52°C (1.4°F to 125.6°F)	
Internal Heater Operating Temperature Range ^(c)	Not applicable	-17°C to 8°C (1.4°F to 46.4°F)
Storage Temperature (1 month) ^(d)	-20°C to 55°C (-4°F to 131°F)	
Storage Temperature (6 months) ^(d)	-10°C to 30°C (14°F to 86°F)	
<p>^(a) Specifies the temperature of the cells and not the ambient temperature. Ambient temperature and cell temperature may not be the same.</p> <p>^(b) Although the Battery Management System (BMS) does not allow charging when cells are below 4°C (39.2°F), the 48-48-5120-H has a heater that warms the battery to a temperature that enables charging to resume at 4°C (39.2°F).</p> <p>^(c) When the 48-48-5120-H battery cells are between -17°C (1.4°F) and 5°C (41°F) and either connected to a charging source or the battery SOC is 50% or more, energy is diverted to the internal heater until the battery reaches 8°C (46.4°F).</p> <p>^(d) Storage outside of specified temperatures will result in permanent capacity loss and void the warranty.</p>		

3.4 Protections Specifications

Table 3-4, AES RACKMOUNT Protections Specifications

Protection Specifications	48-48-5120 900-0062 / 48-48-5120-H 900-0067
Overvoltage	
Protection ^(a)	Above 58.24 V for 3 seconds
Recovery ^(a)	Recovery after 120 seconds and less than 55.2 V
Undervoltage	
Protection ^(b)	Less than 43.2 V for 5 seconds
Recovery ^(b)	No automatic recovery. The battery module shuts down after 120 seconds.
Over-Charge Current	
Protection	Greater than 97 A for 10 seconds
Recovery	Recovery after 120 seconds
Over-Discharge Current	
Protection ^(c)	3-second rating 218 A
Recovery ^(c)	Recovery after 120 seconds
Over-temperature in Discharge	
Protection ^(d)	Cell temperature above 52°C (125.6°F) for 5 seconds
Recovery ^(d)	Cell temperature below 50°C (122°F)
Under-temperature in Discharge	
Protection ^(d)	Cell temperature below -17°C (1.4°F) for 5 seconds
Recovery ^(d)	Cell temperature above -15°C (5°F)
Over-temperature in Charge	
Protection ^(d)	Cell temperature above 52°C (125.6°F) for 5 seconds
Recovery ^(d)	Cell temperature below 40°C (104°F)

Under-temperature in Charge	
Protection (d)	Cell temperature below 4°C (39.2°F) for 5 seconds and charge current detected
Recovery (d)	Recovery after 120 seconds and cell temperature 4°C (39.2°F) or higher. Note: Discharge is available to -17°C (1.4°F).
Load Qualification Protection	
Protection	Mixed System Voltage, Short Circuit, Reverse Polarity, Input Capacitance Overload
Recovery	Re-qualify after 120 seconds. After ten failed attempts to qualify, the battery module switches OFF.
<p>(a) Overvoltage protection monitors individual cell voltages. Protection is triggered when any cell is over 3.64 VPC and recovers when all cells are below 3.45 VPC for 120 seconds. Voltages are provided for guidance only.</p> <p>(b) Undervoltage protection monitors the voltage of individual cells. Protection is triggered, and the battery module is set to OFF when any cell is at or below 2.7 VPC. Manually set the battery module ON to recover. Voltages are provided for guidance only.</p> <p>(c) For time versus current interrupt details, refer to Figure 2. Over-Discharge Protection Time Curve.</p> <p>(d) Specifies the temperature of the cells and not the ambient temperature. Ambient temperature and cell temperature may not be the same.</p>	

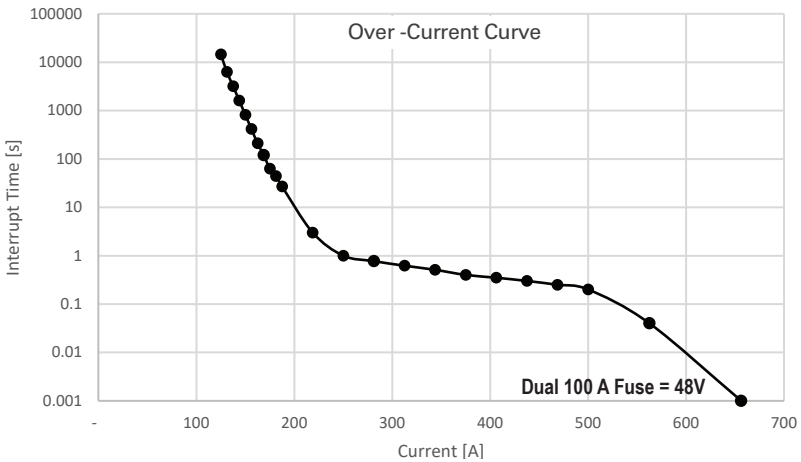

Figure 2. Over-Discharge Protection Time Curve

3.4.1 Breaker Delay Specifications

Table 3-5, Breaker Delay

Rating [%]	Current	Delay Time [s]
100	100 A	Breaker should not trip
100-135	100 - 135 A	Breaker may trip ⁽¹⁾
135	135 A	2.0 - 60.0
150	150 A	1.2 - 40.0
200	200 A	0.6 - 20.0
400	400 A	0.3 - 3.0
600	600 A	0.15 - 1.3

⁽¹⁾ The breaker may trip due to the tolerance range.

3.5 Internal Heating Specifications

Internal heating is available on the **48-48-5120-H (900-0067)** model only.

Table 3-6, 48-48-5120H Internal Heating Specifications

Internal Heating Specifications	48-48-5120-H 900-0067
Heating Power	50 W
Heating On ^(a)	<ul style="list-style-type: none">• Below 5°C (41°F), and• Either charge detected or SOC is 50% or more
Heating Off ^(a)	<ul style="list-style-type: none">• Temperature above 8°C (46.4°F), or• No charge current detected and SOC is less than 50%

^(a) Specifies the temperature of the cells, not the ambient temperature. Ambient temperature and cell temperature may not be the same.

3.6 Minimum Specifications for Battery Module Systems

Install AES RACKMOUNT battery modules in parallel in a battery bank configuration to increase system capacity. Overall battery module system capacity must be correctly sized to meet the requirements of the load and account for:

- Total Max Charge Current (1 hour)
- Total Max Continuous Charge Current
- Total Peak Current
- Total Max Discharge Current (1 hour)
- Total Max Continuous Discharge Current

If charging for 1 hour or less at a time, the total charging capacity of all charging sources in the system should not exceed the Max Charge Current (1 hour) operating limit of all the battery modules in the system. The same is true if discharging for 1 hour or less at a time. The total discharging capacity of all loads in the system should not exceed the Max Discharge Current (1 hour) operating limit of all the battery modules in the system.

If charging and discharging for repeated cycles, the total charging capacity of all charging sources in the system should not exceed the Max Continuous Charge Current and Max Continuous Discharge Current operating limits of all the battery modules in the system.

If the Max Charge Current (1 hour) or Max Discharge Current (1 hour) is exceeded for any battery in the system, the BMS in that battery will trigger the over-current protection and disconnect. The charging system's maximum charge current must be below the operating limit of installed battery modules or be curtailed.

If the Max Continuous Charge Current or Max Continuous Discharge Current is exceeded for multiple cycles, the battery is quicker to trigger the over-temperature protections and disconnect.

The sum of all the Peak Current values for the attached loads must be less than the Peak Current of the battery module system, including inrush current values, for any motors and surge values for any inverters.

For AES RACKMOUNT battery modules installed in parallel in a battery bank configuration, the sum of all battery module capacities provides the overall capacity value for the battery module system. [Table 3-7](#) provides DC capacity values for sample Discover battery module systems.

NOTICE

- Exceeding the Peak Current, or continually exceeding the Max Charge Current (1 hour), Max Discharge Current (1 hour), Max Continuous Charge Current, or Max Continuous Discharge Current, of all the battery modules in the system will lead to triggering the battery module BMS over-temperature protection quicker, resulting in disconnection of all battery modules in the system.
- Disconnection will result in a voltage spike (Load Dump), which may damage any component electrically attached to the battery module system.

NOTE

The maximum number of battery modules installed in a parallel configuration is 24.

Table 3-7, 48-48-5120 / 48-48-5120-H DC Capacity Values for Sample Battery Module Systems (@25°C, 77°F)

Parallel System	Peak Current	Max Discharge Current (1 hr)	Max Continuous Discharge Current	Max Charge Current (1 hr)	Max Continuous Charge Current	Usable Capacity
1 battery module	218 A	95 A	70 A	95 A	70 A	5 kWh
2 battery modules	436 A	190 A	140 A	190 A	140 A	10 kWh
3 battery modules	654 A	285 A	210 A	285 A	210 A	15 kWh
4 battery modules	872 A	380 A	280 A	380 A	280 A	20 kWh
5 battery modules	1090 A	475 A	350 A	475 A	350 A	25 kWh
6 battery modules	1308 A	570 A	420 A	570 A	420 A	30 kWh

3.7 Regulatory

Table 3-8, 48-48-5120 / 48-48-5120-H Regulatory

Regulatory
UN38.3 Transportation
IEC62619
UL1973
UL9540A
UL9540
EN61000-6-2
EN61000-6-3
FCC Class B
CE Marking

EMC

The battery has been tested and found to comply with the limits for a Class B digital device, pursuant to part 15 of the FCC Rules. These limits are designed to provide reasonable protection against harmful interference in a residential installation. The battery generates, uses and can radiate radio frequency energy and, if not installed and used in accordance with the instructions, may cause harmful interference to radio communications. However, there is no guarantee that interference will not occur in a particular installation.

If the battery does cause harmful interference to radio or television reception, which can be determined by turning the battery off and on, the user is encouraged to try to correct the interference by one or more of the following measures:

- Reorient or relocate the receiving antenna.
- Increase the separation between the battery and receiver.
- Connect the battery to an electrical circuit different from that to which the receiver is connected.
- Consult the dealer or an experienced radio/TV technician for help.

4. TRANSPORTATION

Transport it in the original package or equivalent if the battery module is not installed in equipment. Per the UN Handbook of Tests and Criteria, battery modules are tested to part III, subsection 38.3 (ST/SG/AC.10/11/ Rev. 5). For transportation, the battery modules belong to category UN3480, Class 9.

5. HANDLING

Before handling:

- Keep the battery module away from sparks and flames
- Disconnect the cables from the battery module
- Protect battery module terminals from short-circuiting and touch
- Do not lift or carry the battery module while it is in use or in operation
- Do not lift the battery module by attached battery cables
- Set the battery module Breaker in the OFF (Open) position

6. FEATURES

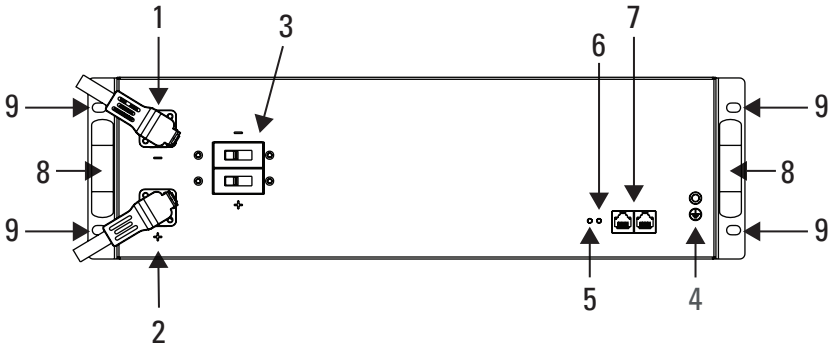

Figure 3. AES RACKMOUNT Battery Module Components

Item	Description
1	Battery module negative (-) black, Amphenol SurLok Plus connector
2	Battery module positive (+) red, Amphenol SurLok Plus connector
3	Two Pole Breaker
4	Equipment Ground
5	At-a-glance LED
6	ON/OFF Key
7	LYNK Port x 2
8	Handles
9	Mounting Points

6.1 Battery Module Breaker

The battery module Breaker protects the electronic components of the battery module's internal BMS from high, externally generated currents.

NOTICE

The Breaker and the BMS are independent. Setting the Breaker to the ON (Closed) position does not switch the BMS ON. Setting the Breaker to the OFF (Open) position does not switch the BMS OFF. Independently set the BMS ON or OFF with the ON/OFF key.

NOTE

Additional external DC fusing may be required to protect the battery cables from DC overcurrent and to meet installation codes.

6.2 Battery Module ON/OFF Key

1. To turn ON the battery module, first switch the breaker to the ON (closed) position.
2. Briefly press the battery module's ON/OFF key to switch the battery module ON.
3. To turn OFF the battery module, briefly press the ON/OFF key.
4. If desired, switch the breaker to the OFF (open) position.

NOTICE

The Breaker and the BMS are independent. Setting the Breaker to the ON (Closed) position does not switch the BMS ON. Setting the Breaker to the OFF (Open) position does not switch the BMS OFF. Independently set the BMS ON or OFF with the ON/OFF key.

6.3 At-a-glance LED

WARNING

ELECTRIC SHOCK AND FIRE HAZARD

- Always assume the battery module's main relay is ON (Closed), even if the At-a-glance LED shows that it may be off.
- Verify the terminal voltage with a voltmeter before handling and installing the battery module.

Failure to follow these instructions may result in death or serious injury.

Table 6-1, At-a-glance LED States

LED	Description
No LED light	The battery module main relay is OFF (Open).
Solid green	The main relay is ON (Closed), and the battery module is ready for operation.
Flashing orange	The main relay is ON (Closed), but one or more operating parameters (voltage, current, temperature) have exceeded a fault threshold. Unless the condition is corrected, the battery module transitions to protection mode after about ten seconds, and the main relay switches OFF (Open).
Flashing red	The main relay is OFF (Open), the battery module is in protection mode, and a fault has occurred. For a list of faults, refer to Table 3-4, AES RACKMOUNT Protections Specifications .

NOTE

The At-a-glance LED does not communicate the breaker position. Visually inspect the breaker position.

6.4 LYNK Port

The LYNK Port enables multiple Discover battery modules to communicate and interact in a closed-loop network. LYNK Port enables networking AES RACKMOUNT battery modules in a closed-loop system with other networked devices such as inverter-chargers. A closed-loop system enhances safety and optimizes system performance.

6.4.1 LYNK Port Communication RJ45 Pin Assignment

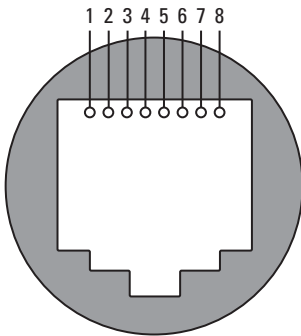

Figure 4. LYNK Port Communication RJ45 pin assignment

Pin Number	Function
1 (1)	Reserved. Do not use.
2 (1)	Reserved. Do not use.
3 (1)	Reserved. Do not use.
4	CAN Low
5	CAN High
6 (1)	Reserved. Do not use.
7	CAN Ground
8	CAN Ground

(1) Do not populate. Do not terminate to power. Do not terminate to ground. Do not terminate to CAN_L or CAN_H.

NOTICE

- Use a straight-through cable. Do not use a cross-over cable.
- Isolate unused pins. Crossing pin functions may cause system damage.
- Do not terminate unused wires to ground, power, or other functions.
- Mixing the LYNK Network with other networks may result in equipment malfunction and damage.

6.5 Equipment Ground

Ground each battery module to a suitable ground point on the selected installation equipment using a #6 gauge wire or larger diameter. Ground the equipment to earth using a #4 gauge wire or larger diameter.

NOTE

Refer to the applicable code and check with the authority having jurisdiction to confirm local requirements.

7. THEORY OF OPERATION

7.1 Ingress Protection IP20

Ingress protection rates the degree of protection provided by mechanical casings and electrical enclosures against intrusion, dust, accidental contact, and water under specified conditions. The IP20 rating indicates that the product is touch-proof and resistant to dust or objects larger than 12 mm. However, it has no protection against liquids, so it is susceptible to damage if it comes into contact with water sprays.

IP codes guide suitability for use under different environmental conditions. IP ratings do not indicate fitness for purpose or confer a performance guarantee.

7.2 Internal Heating (48-48-5120-H)

The battery module with part number 48-48-5120-H is equipped with internal heating. When the battery module's internal temperature is below 5°C (41°F) and the battery module is either connected to a charging source or SOC is 50% or more, energy is diverted to the internal heating element to avoid the under-temperature fault.

The heating stops when:

1. The battery module's internal temperature reaches 8°C (46.4°F).
 - Once the cell temperature reaches this threshold, all the energy is directed to charging the cells.
2. No charge current is detected and SOC is less than 50%.
 - After the heating stops, if the battery module's internal temperature drops below 5°C (41°F) and the battery module is connected to a charging source, the heater turns ON again.

For information about internal heating, refer to Sections [3.4 Protections Specifications](#) and [3.5 Internal Heating Specifications](#).

NOTE
Charging and heating can occur simultaneously. However, the BMS will not allow charging to continue when cell temperature is below 4°C (39.2°F) for 5 seconds.

7.3 Battery Management System

7.3.1 Battery Management System Protections

The Battery Management System's (BMS) primary function is to monitor cell module voltage, temperature, and battery current. The BMS uses this information to maintain cell operation within operating specifications. If a parameter falls outside of operating specifications, the BMS will disconnect and protect the battery module from:

1. **Overvoltage:** Charge voltages that are too high.
2. **Undervoltage:** Discharged voltage that is too low.
3. **Overcurrent:** Current is too high when powering up a load (high inrush current) or from a sustained charging or discharging current above the specified limit.
4. **Over-temperature:** Cell temperature that is too high during charge and discharge.
5. **Under-temperature:** Cell temperature that is too low during charge and discharge.
6. **Load Qualification:** Protection may occur when switching the battery module ON. The protection qualifies the load attached to it to prevent switching ON into a reverse polarity, short circuit, mixed voltage system, or large capacitive load.

For trigger and recovery values, refer to [Table 3-4, AES RACKMOUNT Protections Specifications](#).

The BMS reconnects when it hits recovery thresholds. Manually switch the battery module ON if the BMS disconnects due to low voltage protection. A physical disconnect switch is recommended to reconnect the battery module if the system has a constant parasitic draw.

After a load qualification fault, there is a 120-second delay until you can switch ON the battery module again. In other words, if a user switches the battery module OFF after a load qualification fault, the user cannot switch the battery module ON again until the 120-second delay is over.

NOTE

- Charge and discharge have different operating temperature limits.
- If the BMS disconnects in response to temperature or current limits, wait for the temperature or current to reach normal operating limits before switching the battery module ON.

7.3.2 BMS Pre-Charge System

Turn on all the batteries in the battery bank before energizing any inverter-chargers to prevent blowing a fuse while trying to pre-charge the system.

The battery module has a Pre-Charge System to energize external capacitive loads before switching the main relay ON. The maximum input capacitance for a single battery module should not exceed the values in [Table 3-1, AES RACKMOUNT Electrical Specifications](#).

NOTICE

When switching ON battery modules, the inrush current may cause the battery modules to fault as they energize external capacitive loads. If the battery fails to turn ON, it retries up to 10 times. Verify the cables and connections, then switch ON the battery modules again.

7.3.3 Battery Management System Load Qualification

When the battery module switches from the OFF state to the ON state, the battery module BMS will qualify the external load before switching ON the main relay. Load qualification will reject switching ON into short circuit, reverse polarity, mixed voltage systems, or capacitive loads that exceed the battery modules limits.

The battery module will attempt Load Qualification a maximum of ten times. After ten failed attempts at Load Qualification, the battery module switches OFF.

During Load Qualification, or when a load is disqualified, the At-a-glance LED flashes red.

7.3.4 Battery Management System Cell Balancing

The cell balancing circuits in the battery module compare all cells in a battery module and balance the cell voltage at the end of the charge. When there is a network of battery modules over the LYNK port, all battery module cells are balanced as an entire system, not as individual battery modules.

7.3.5 Battery Module Charge and Discharge Settings

Closed-loop communication with a Power Conversion device requires using the LYNK II Gateway Communication device from Discover Energy Systems. For details, please refer to the relevant LYNK Gateway Communication User Manual available from the www.discoverlithium.com website, or contact your Discover Energy Systems provider for assistance.

Refer to the appropriate Application Note available from www.discoverlithium.com for the set up of closed-loop parameters and integration with specific brands of solar inverter-chargers, solar charger controllers, mobile inverter-chargers, and industrial chargers.

7.4 LYNK Network Communication

Discover battery modules use CAN communication over the LYNK Network to coordinate performance with other battery modules and communicate with accessories such as the LYNK II Communication Gateway.

NOTICE

The battery module has intelligent CAN termination. Terminating resistors are not required when deploying the battery module in a LYNK Network.

7.4.1 LYNK Network Power

A Discover battery module provides the LYNK Network power through the LYNK Port. Discover documentation specifies how many battery modules are required to provide sufficient power for the LYNK Network and compatible accessories. Some accessories may require more than one battery module to provide sufficient power.

NOTICE

Do not use an external power source to power devices over the LYNK Network.

7.4.2 LYNK Network Size

One LYNK Network can support up to 36 AES RACKMOUNT Battery Modules. The total length of the LYNK network cables must not exceed 30 m (98.42 ft).

7.4.3 LYNK Network Cables

CAT6 cables (included with AES RACKMOUNT battery modules) network AES RACKMOUNT battery modules.

8. OPTIONAL ACCESSORIES

The following optional accessories are available for the AES RACKMOUNT battery module.

Table 8-1, AES RACKMOUNT Accessories

Accessory	Part Number
LYNK II Communication Gateway	950-0025
AES RACKMOUNT Battery Module Combiner	950-0049
AES RACKMOUNT Quick Stack Rack	950-0050
AES RACKMOUNT Slimline Enclosure	950-0053
AES RACKMOUNT Terminal Connector Set	950-0054
Slimline Enclosure Fan Kit	950-0064

9. INSTALLATION

The following instructions describe how to connect single or multiple battery modules in parallel to the LYNK communication device.

Instructions on installing the battery module in an enclosure are not provided.

WARNING

ELECTRIC SHOCK AND FIRE HAZARD

- This equipment must only be installed as specified.
- Do not disassemble or modify the battery module.
- Do not touch exposed contents if the battery module case has been damaged.
- There are no user-serviceable parts inside.

Failure to follow these instructions may result in injury.

NOTICE

- Some chargers and inverters support temperature-compensated charging. Disable temperature-compensated charging on the charger or inverter.
- Do not use or install a battery temperature sensor.

NOTE

It is the responsibility of the installer to ensure that all applicable installation requirements and standards are met.

9.1 Tools

- Insulated tools sized to match nuts, bolts, and cables
- RMS type Voltmeter
- Personal protective equipment

9.2 Location

The AES RACKMOUNT battery module can be installed outdoors when housed in a suitable outdoor rated enclosure. Otherwise, it is for indoor installations only.

Battery modules can be installed in enclosures from Discover, or a nineteen-inch four-post metal rack with at least 1U (44.45 mm, 1.75 inch) spacing on the top and sides to allow for airflow and heat dissipation, and rated to support the weight of cables and the battery modules (number of batteries x 44.0 kg [97.0 lb]).

NOTE

The scope of certifications for the AES RACKMOUNT battery module do not extend to any third-party supplied racks.

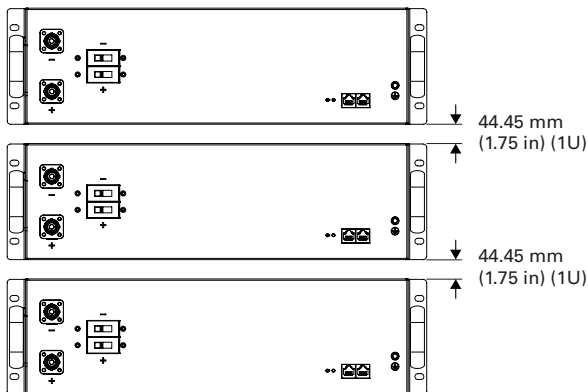

Figure 5. Battery spacing

Install the battery module in locations that meet the following requirements:

1. **Do not install in direct sunlight.** Avoid installing the battery module in an area with high ambient temperature.

2. **Moderate temperature.** The ambient temperature should be between 4°C and 40°C (39.2°F and 104°F). Ambient temperatures of 15°C to 20°C (59°F to 68°F) are ideal for extending LiFePO₄ battery life.
3. **Ventilation.** Do not install in zero-clearance compartments. Allow spacing of at least 44.45 mm (1.75 in) (1U) above the top cover, between battery modules, and to the sides for airflow. In the room housing the batteries, add vents to allow airflow to the outdoors.
4. **Away from water.** Do not install in locations that are susceptible to flood or water leakage.
5. **Orientation.** Install the battery module in any direction other than face down. Do not install face-down.

Additional requirements for mobile or in-vehicle installations:

1. **Do not install in an engine compartment.** Do not install the battery module in an area where gasoline fuel is present. Avoid installing the battery module in an area with high ambient temperature.
2. **Secure the battery.** Locate the battery module in a battery compartment. Secure the battery module with strapping or a bracket to prevent movement and strain on the battery module and cables.

NOTE

- Do not attach the battery module to a frame or mounting location with excessive vibrations.
- Using this product in a location that does not meet requirements will void the warranty

9.3 DC Cables

⚠ CAUTION

FIRE HAZARD

Undersized cables can become hot and may potentially catch fire.

Failure to follow these instructions can result in minor to moderate injury.

The DC battery cables should meet the following requirements:

1. **Copper-stranded cable.** DC cables must be stranded, copper, and rated 90 °C minimum. Terminate the cables with lugs that fit the DC terminals.
2. **Minimum cable lengths.** Select a location that minimizes the length of battery cables to reduce voltage drop from the impedance leading to reduced performance.
3. **Appropriate cable gauge** (3 AWG, 26.5 mm². 4AWG, 25 mm² is also acceptable.) The cables should be capable of carrying the normally expected current, plus a margin of safety.
4. **Proper polarity.** Positive (+) is connected to positive (+), and negative (-) is connected to negative (-). Verify the polarity of all connections before energizing batteries.

9.4 DC Protection

CAUTION

FIRE HAZARD

- Undersized fuses and disconnects may become overloaded and potentially cause a fire.
- Fuses and disconnects are required to open before the cable reaches its maximum current carrying capability.

Failure to follow these instructions can result in minor to moderate injury.

Each battery module comes equipped with an integrated breaker that opens both the positive and negative poles. When multiple battery modules are installed in parallel, additional DC overcurrent protection is recommended between the battery bank and inverter-charger.

1. **Appropriate size.** Size the fuses and disconnects following local codes to protect the wiring in the system and are required to open before the cable reaches its maximum current carrying capability.
2. **Install protection in the positive cable.** The fuse and disconnect should be located close to the battery module and installed in the positive cable. Local codes may limit how far the protection can be from the battery module.

NOTE

- AC circuit breakers and DC circuit breakers are not interchangeable. Check the label on the circuit breaker to ensure it is the correct type and rating. Use only DC circuit breakers.
- The local electrical code in your area may require both positive and negative DC disconnect switches. Refer to the applicable code and check with the authority having jurisdiction to confirm local requirements.

9.5 Terminal Connections and Hardware

Amphenol SurLok Plus connectors with the following part numbers are used to mate with the receiving pins on the battery module face plate.

- Positive (+) Red - C10-730186-200
 - Negative (-) Black - C10-730186-100
1. **Plug the Connector Into the Receiving Pin.** Connect all power connectors appropriately to the receiving pin.
 2. **Engage the Lock.** Push down until you hear a click to ensure the mating lock is engaged.

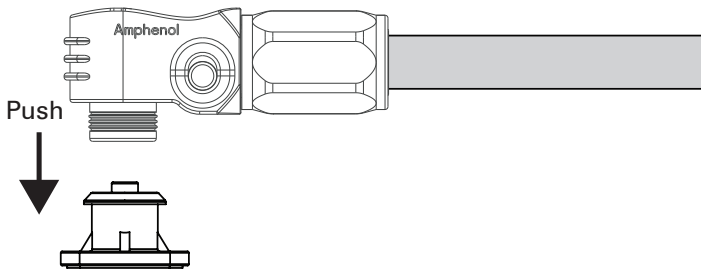

Figure 6. Battery Terminal connection

NOTICE

Failure to securely engage the mating lock on a terminal connection will increase resistance and lower voltage, leading to burnout of the terminals.

NOTE

Without exception, a product experiencing terminal burnout will void the warranty.

9.6 Single Battery Module Installation Procedure

Install equipment following the standards set by the local authority having jurisdiction.

⚠ CAUTION

FIRE HAZARD

Use cables that meet specifications. Undersized cables can become hot and potentially catch fire.

Failure to follow these instructions can result in minor to moderate injury.

To optimize performance, battery cables (battery module to load and battery module to charger) must meet the following requirements:

1. **Minimum cable length.** Select a location that minimizes the length of battery cables to reduce the voltage drop.
2. **Equal cable gauge.** The battery cables should be the same gauge.
3. **Equal cable length.** The battery cables should be of equal length.

9.6.1 Installation Procedure

⚠ CAUTION

ELECTRIC SHOCK AND FIRE HAZARD

- Take precautions to avoid bridging the terminals.
- Do not contact the terminals with metal mountings, fixtures, or body parts.

Failure to follow these instructions can result in minor to moderate injury.

Install equipment following the standards set by the local authority having jurisdiction.

1. If the circuit in which the battery module is installed has a disconnect, open the disconnect to isolate the battery module.
2. Set both the battery module BMS and the Breaker to the OFF position.
3. Use a DMM or other voltage measuring device to confirm the circuit is de-energized.
4. Ensure the cable connections are clean and in working order.
5. Install and secure the new battery module.
6. Connect the battery cable-end lugs to the DC bus.
 - Connect only the positive (+) cable lug to the positive (+) busbar.
 - Connect the negative (-) cable lug to the negative busbar (-) last to avoid sparks.
 - Short circuits may damage the battery module, voiding the warranty.
7. Connect cable connectors to the battery module receiving pins and engage mating locks.
 - First, connect only the positive (+) connector to the positive (+) receiving pin.
 - Connect the negative (-) connector to the negative (-) receiving pin last to avoid sparks.Refer to Section [9.5 Terminal Connections and Hardware](#).
8. If using the LYNK Gateway, connect the battery modules.
 - Attach a CAT5 or higher cable to the LYNK port on the battery module.
 - Attach the other end of the cable to the LYNK Gateway.Refer to Section [9.8.2 Network Installation](#).
9. Set the battery module Breaker ON (close).
10. Set the battery module BMS ON (ON/OFF key).
11. Close the disconnect if it is open.

NOTICE

- Avoid short circuits. Short circuits may damage the battery module and will void the warranty.
- Failure to engage the mating lock on a terminal connection will increase resistance and lower voltage, leading to burnout of the terminals and voiding of the warranty.

NOTICE

- Some inverter-chargers support temperature-compensated charging. Disable temperature compensated charging on the charger or inverter.
- Do not use or install a battery temperature sensor.

9.7 Parallel Battery Module Installation Procedure

⚠ CAUTION

FIRE HAZARD

Use cables that meet specifications. Undersized cables can become hot and may potentially catch fire.

Failure to follow these instructions can result in minor to moderate injury.

Battery modules used in a parallel system must meet the following requirements:

1. **Same model.** Battery modules must be the same model.
2. **Equal voltage.** The battery module has a Pre-Charge System that allows you to connect battery modules at different SOC. The best practice is to confirm battery modules are within 50 mV (0.05 V) of each other before installing them in parallel.

Battery cables connecting to the DC bus must meet the following requirements to optimize performance:

1. **Minimum cable length.** Select a location that minimizes the length of battery cables to reduce voltage drop from the impedance.
2. **Equal cable gauge.** The interconnection cables should be the same gauge.
3. **Equal cable length.** The interconnection cables should be of equal length.

9.7.1 Installation Procedure

⚠ CAUTION

ELECTRIC SHOCK AND FIRE HAZARD

- Take precautions to avoid bridging the terminals.
- Do not contact the terminals with metal mountings, fixtures, or body parts.

Failure to follow these instructions can result in minor to moderate injury.

Install equipment following the standards set by the local authority having jurisdiction.

1. If the circuit where the battery modules are installed has a disconnect, open the disconnect to isolate the battery modules.
2. Set all battery BMS to the OFF position.
3. Set all battery Breakers to the OFF position.
4. Use a DMM or other voltage measuring device to confirm the circuit is de-energized.
5. Ensure the cable connections are clean and in working order.
6. Install and secure new battery modules.
7. Connect the ground strap between each battery module and a suitable ground point.

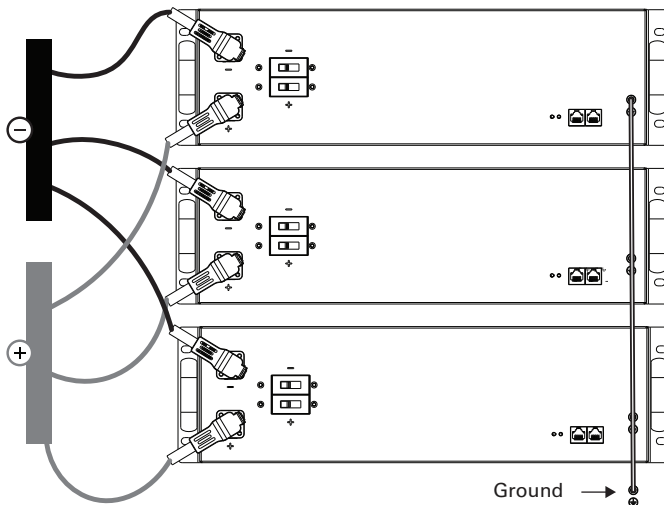

Figure 7. Battery Module Grounding

8. Connect all positive (+) cable lugs to the positive (+) busbar.
9. Connect all negative (-) cable lugs to the negative (-) busbar.
10. Connect all positive (+) battery module connectors to the positive (+) battery module receiving pins and push down to engage mating locks. Refer to Section [9.5 Terminal Connections and Hardware](#).
11. Connect all negative (-) battery module connectors to the negative (-) battery module receiving pins and push down to engage mating locks.

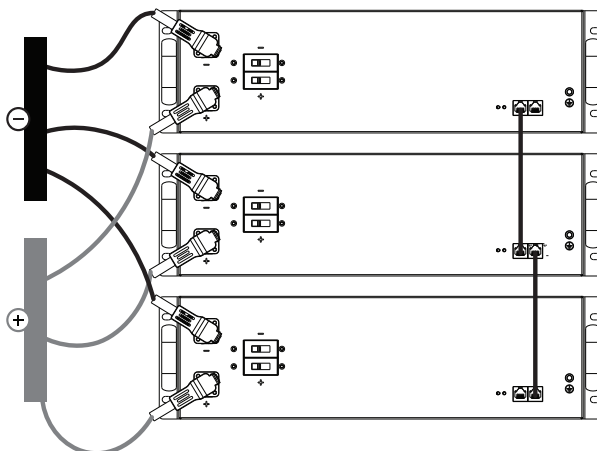

Figure 8. Battery Busbar connection

12. Network the communication port of each battery module using a CAT5 or higher cable.
13. If using the LYNK II Communication Gateway, connect it to the battery modules. Attach a CAT5 or higher cable to the LYNK port on the battery module. Attach the

other end of the cable to the LYNK Gateway.

Refer to Section [9.8.2 Network Installation](#), for instructions.

14. Set all battery module BMS to the ON position.
15. Energize the system by setting all battery module breakers to ON.
16. Close the circuit disconnect (if open).

NOTICE

Failure to securely engage the mating lock will increase resistance and lower voltage, leading to burnout of the terminals and voiding of the warranty.

NOTE

- Whenever replacing an old battery module in a parallel string, use a battery module of the same age, model, capacity, and voltage.
- Before installing the battery module in parallel, charge each module to 100% SOC. Blown battery fuses may result if the battery modules are not at the same SOC.

9.8 LYNK Network

9.8.1 Network Layout

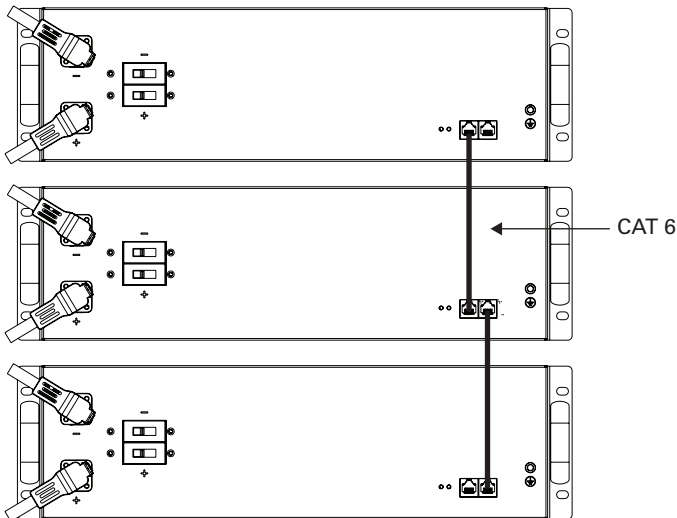

Figure 9. Battery modules connected through CAT6 network cable (provided)

9.8.2 Network Installation

Networking Guidelines:

- **Separate data and power cables.** Allow for separation between data and power cables. Avoid data interference caused by running network cables bundled with power cables.
- **Allow for LYNK Network cable slack.** Ensure that LYNK Network cables are slack and not in tension.
- **Isolate the LYNK Network.** Do not mix other networks with the LYNK Network.

NOTICE

Mixing the LYNK Network with other networks may result in equipment malfunction and damage.

NOTE

Termination resistors are not required when networking with the LYNK Network.

9.8.3 Installation Procedure

1. Before beginning a network installation, mount the devices according to their instructions.
2. Attach a CAT5 or higher cable to the LYNK port on a battery module.
3. Connect the other end of the cable to the LYNK port of the following battery module.
4. Repeat until all battery modules are connected.
5. Network with other devices and accessories as needed.

9.8.4 Testing and Verification of the LYNK Network

Perform network verification with the **LYNK II Communication Gateway (950-0025)**.

- If the LYNK Network Bus indication LED is illuminated, power and communication for the LYNK Network are active.
- Use LYNK ACCESS software through a computer to confirm the number of battery modules in the LYNK Network.

10. OPERATION

The BMS prevents battery module operation outside of specified operating conditions. Understand each of these protections and how to set up the system accordingly. Refer to [Table 3-4, AES RACKMOUNT Protections Specifications](#).

NOTICE

Intentional bypassing of the BMS to operate the battery module outside maximum and minimum limits void the warranty.

10.1 Low Voltage Cut-Off

Appropriate for the application, program the low voltage cut-off at or above the Low Voltage Disconnect in [Table 3-1, AES RACKMOUNT Electrical Specifications](#). This action disconnects the load before the BMS enters low voltage protection.

10.2 State of Charge

A voltage-based battery meter designed for lead-acid batteries will not provide an accurate state-of-charge (SOC) for lithium batteries. The following device, available from Discover Energy Systems, can be used to communicate an accurate state of charge to other devices.

- LYNK II Communication Gateway

NOTICE

Storing or leaving the battery module at 0% SOC will lead to irreversible damage and void the warranty.

10.3 Charging

Each electrical system will have different characteristics and balance-of-system components. Charger settings may require modifications to optimize system performance.

NOTICE

- Always confirm that the charging device cannot produce transient spikes that exceed the published terminal voltage limits for the battery module.
- Always confirm the charging curve meets the battery module's charging requirement.
- Never charge a visibly damaged or frozen battery module.
- If the battery module is stored in a cold environment, it may become frozen and may not accept a charge. Be aware of the supported Charge Temperature range (refer to Section [3.3 Environmental Specifications](#)) for your battery and recharge before it approaches 0% SOC.

10.3.1 Closed-Loop Charging

Closed-loop charging is a method whereby the battery module communicates with a charger and sends the charge voltage and current. Closed-loop charging is available with compatible chargers directly connected to the LYNK port or through the LYNK II Communication Gateway. Closed-loop charging reduces charge time and increases balancing efficiency compared to open-loop charging.

Refer to the appropriate Application Note available from www.discoverlithium.com for the set up of closed-loop parameters and integration with specific brands of solar inverter-chargers, solar charger controllers, mobile inverter-chargers, and industrial chargers.

10.3.2 When to Charge the Battery Module

- **Opportunity charging is OK.** Charging the battery module after every use will not reduce its cycle life.
- **Partial State-of-Charge is OK.** If the battery module SOC is greater than 10% at the end of discharge, it does not require an immediate charge. However, do not continually leave the battery in a partial state of charge as that will reduce its performance as battery cells become unbalanced.

Every 4 cycles, fully charge the battery so the inverter-charger reaches the charge termination criteria. This ensures the battery cells are balanced and that each battery cell is fully charged.

- **Charge if below 10% SOC.** If the battery module has been discharged below 10% SOC, it must be charged within 24 hours to avoid permanent damage to the battery module. Otherwise, irreversible damage to the battery module cells will occur in a very short period of time.

- **Low charge current extends life.** Charging at 50% of nominal current or lower helps extend the battery module cycle life.
- **Charge within the proper temperature range.** Ensure that charging is within the charge temperatures specified in [Table 3-3, AES RACKMOUNT Environmental Specifications](#).

NOTICE

- The battery module must be charged within 24 hours if discharged below 10% SOC. Otherwise, irreversible damage to the battery module cells will occur in a very short period of time and void the warranty.
- Do not continually leave the battery in a partial state of charge as that will unbalance the battery cells. Fully charge the battery every 4 cycles so each battery cell is fully charged. If the end of charge criteria is not regularly performed, multiple balancing charges may be required to fully charge each battery cell.
The following are two ways to perform a balancing charge.
 - Reduce charge termination to 100 mA and maintain 54.4 V for 10 hours.
 - Charge in a closed-loop configuration.

NOTE

When the 48-48-5120-H battery cells are between -17°C (1.4°F) and 5°C (41°F) and either connected to a charging source or SOC is 50% or more, energy is diverted to the internal heater until the battery cells reach 8°C (46.4°F). If the BMS triggered the Under-temperature in Charge protection, the battery module will not allow charging until the cell temperature is 4°C (39.2°F).

10.4 Charging Profile

The Power Conversion device will require setting up a charging profile even if you use closed-loop charging. Using the controller of the Power Conversion device, set up a charging configuration with a Lithium charge profile that matches the charge and discharge settings. Refer to [Table 3-1, AES RACKMOUNT Electrical Specifications](#), for charging parameters.

Refer to the appropriate Application Note from www.discoverlithium.com for setting up closed-loop parameters and integrating inverter-chargers and battery chargers.

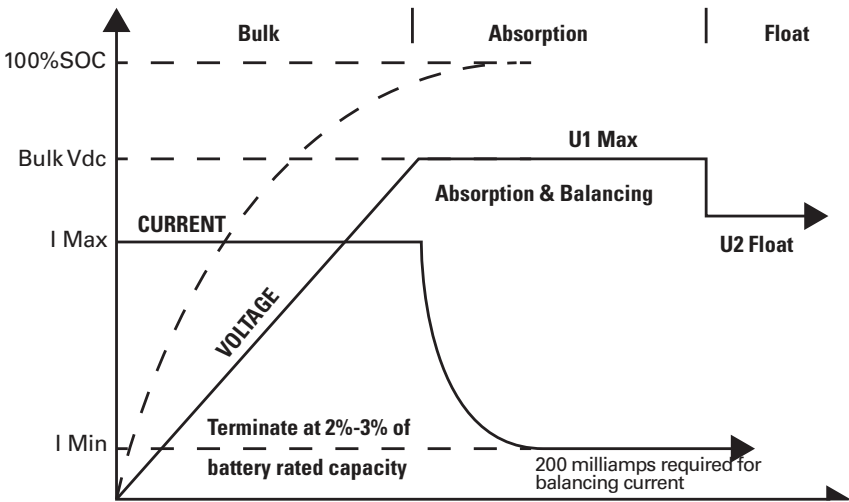

Figure 10. Charge Graph

NOTICE

- Charge with a Lithium charge profile matching the specifications for the AES RACKMOUNT battery module.
- Do not charge using a lead-acid charging profile. Charging using a lead-acid profile will void the warranty.

NOTE

Charging at 50% of nominal current or lower will extend the battery module cycle life.

10.4.1 Bulk Charge

Bulk phase. The Bulk Charge is the first phase of the charging process, called the constant current phase. This phase is when the charger's maximum current is directed to the battery module until reaching the desired voltage. The Bulk phase will recharge the battery module to approximately 90-95% SOC.

A single-stage charge may be appropriate if the charging source is a generator or other charge source that is inefficient at low output current. A single-stage charge will only complete the Bulk phase portion of the charge curve. This method should return the battery module to 90-95% SOC.

Refer to [Table 3-1, AES RACKMOUNT Electrical Specifications](#), for charging parameters.

10.4.2 Absorption Charge

Absorption phase. The second phase of the charging process is Absorption Charge, also called the constant voltage phase. In this phase, the charger reduces current accordingly to maintain the desired voltage.

Refer to [Table 3-1, AES RACKMOUNT Electrical Specifications](#), for charging parameters.

10.4.3 Equalization Charge

CAUTION

FIRE AND BURN HAZARD

Do not perform an equalization charge on the AES RACKMOUNT battery module.

Failure to follow these instructions can result in minor to moderate injury.

Do not equalize charge the AES RACKMOUNT battery module. Equalization charging is intended only for lead-acid batteries. An equalization charge is a purposeful overcharge that targets a voltage above the standard charge voltage to remove sulphate crystals that form on lead-acid plates over time.

10.4.4 Float Charge

Float phase. Float charge, the third phase of charging, is optional. During this stage, the battery module is maintained at 100% SOC for extended periods, counteracting any self-discharge or parasitic loads.

- **Not necessary.** Float charging is not required.

Refer to [Table 3-1, AES RACKMOUNT Electrical Specifications](#), for float parameters if needed.

11. ROUTINE INSPECTION

CAUTION

ELECTRIC SHOCK HAZARD

- Do not touch the energized surfaces of any electrical component in the battery module system.
- Before servicing the battery module, follow all procedures to fully de-energize the battery module system.
- Follow [1.4 Safe Handling Procedures](#) when working with the battery module.

Failure to follow these instructions may result in injury.

Periodically inspect the battery module:

1. Ensure that all DC cables are secure and fasteners are torqued properly.
2. Inspect and clean network and battery connectors of dirt and debris.
3. Ensure all networking cables and connectors are secure and tight.
4. Ensure that the installation location is clean and free from debris.
5. Inspect for cracks or bulging in the battery module case.
6. Replace any damaged battery modules.
7. Replace any damaged cables.

12. STORAGE

Leaving the battery module connected to a trickle load or power electronics will cause the battery module to discharge during storage. Without any load, the battery module will self-discharge by approximately 3% per month while in storage. After storage, charge the battery module to 100% SOC and perform at least one full discharge and charge cycle before returning the battery module to service.

1. **Store at 95% SOC or more.** To store the battery module for up to 6 months, store the battery module at 95% SOC or more. It must remain disconnected from all loads and power electronics during storage.
2. **Switch OFF the battery module.** Set the battery module to OFF.
3. **Check SOC every six months.** Recharge the battery module to above 95% SOC every six months.
4. **Proper storage temperature.** Ensure storage is within the temperatures specified below.
 - 1 Month storage temperature -20°C to 55°C (-4°F to 131°F)
 - 6 Month storage temperature -10°C to 30°C (14°F to 86°F)

NOTICE

- Leaving the battery module connected to a load or power electronics during storage may subject the battery module to discharge, resulting in irreversible damage and voiding the warranty.
- Storing the battery module outside specified temperatures will result in irreversible damage and void the warranty.

NOTICE

- Storing or leaving the battery module at 0% SOC will result in irreversible damage and void the warranty.
- If the battery module is stored in a cold environment, it may become frozen and may not accept a charge. Be aware of your battery's supported Charge Temperature range (refer to Section [3.3 Environmental Specifications](#)) and recharge before it approaches 0% SOC.
- Allowing the battery module to self-discharge below an open-circuit voltage of 3.0 VPC will cause irreversible damage and void the warranty.

13. BATTERY MODULE FIRMWARE AND DATA LOGS

Always ensure the battery module is using the latest firmware. The **LYNK Communication Gateway** device and **LYNK ACCESS** Software for 64-bit Windows 10 are required to update the battery module firmware and to download data logs from the battery module. **LYNK Communication Gateway** devices are available from Discover Energy Systems dealers and distributors. Get the latest **LYNK ACCESS** Software and battery module operating firmware from the Discover Energy Systems website at discoverlithium.com.

14. TROUBLESHOOTING

Accurate troubleshooting and warranty claims require data logs from each battery module. **LYNK ACCESS** Software for 64-bit Windows 10 is required to download data logs from each battery module in the system through a USB connection to the **LYNK II Communication Gateway** device that is networked to all battery modules in the system. System owners are encouraged to install the **LYNK II Communication Gateway** and **LYNK ACCESS** software on a laptop to monitor and troubleshoot their system.

NOTICE

If you encounter issues with the battery, please promptly contact the service center. Leaving a battery in an error state for an extended period of time could cause the battery to become unrecoverable and void the warranty.

A battery is unrecoverable once battery cells are below 2 VPC — when the battery voltage is 32 V.

15. RELATED INFORMATION

For warranty information, refer to 885-0043 Discover AES RACKMOUNT Battery Module Warranty Policy, available from the Discover Energy Systems website at discoverlithium.com.

16. GLOSSARY OF TERMS, ABBREVIATIONS, AND ACRONYMS

AFB Arc Flash Boundary	LFP LiFePO ₄ , Lithium Iron Phosphate
BMS Battery Management System	RMS Root Mean Square
DOD Depth of Discharge	SOC State of Charge
IBF Bolted Fault Current	VPC Volts Per Cell

NOTES
